

CNC

8070

Hardware configuration.

(Ref: 1709)



FAGOR AUTOMATION

TRANSLATION OF THE ORIGINAL MANUAL

This manual is a translation of the original manual. This manual, as well as the documents derived from it, have been drafted in Spanish. In the event of any contradictions between the document in Spanish and its translations, the wording in the Spanish version shall prevail. The original manual will be labeled with the text "ORIGINAL MANUAL".

MACHINE SAFETY

It is up to the machine manufacturer to make sure that the safety of the machine is enabled in order to prevent personal injury and damage to the CNC or to the products connected to it. On start-up and while validating CNC parameters, it checks the status of the following safety elements. If any of them is disabled, the CNC shows the following warning message.

- Feedback alarm for analog axes.
- Software limits for analog and sercos linear axes.
- Following error monitoring for analog and sercos axes (except the spindle) both at the CNC and at the drives.
- Tendency test on analog axes.

FAGOR AUTOMATION shall not be held responsible for any personal injuries or physical damage caused or suffered by the CNC resulting from any of the safety elements being disabled.

HARDWARE EXPANSIONS

FAGOR AUTOMATION shall not be held responsible for any personal injuries or physical damage caused or suffered by the CNC resulting from any hardware manipulation by personnel unauthorized by Fagor Automation.

If the CNC hardware is modified by personnel unauthorized by Fagor Automation, it will no longer be under warranty.

COMPUTER VIRUSES

FAGOR AUTOMATION guarantees that the software installed contains no computer viruses. It is up to the user to keep the unit virus free in order to guarantee its proper operation. Computer viruses at the CNC may cause it to malfunction.

FAGOR AUTOMATION shall not be held responsible for any personal injuries or physical damage caused or suffered by the CNC due a computer virus in the system.

If a computer virus is found in the system, the unit will no longer be under warranty.

DUAL-USE PRODUCTS

Products manufactured by FAGOR AUTOMATION since April 1st 2014 will include "-MDU" in their identification if they are included on the list of dual-use products according to regulation UE 428/2009 and require an export license depending on destination.



FAGOR AUTOMATION

All rights reserved. No part of this documentation may be transmitted, transcribed, stored in a backup device or translated into another language without Fagor Automation's consent. Unauthorized copying or distributing of this software is prohibited.

The information described in this manual may be subject to changes due to technical modifications. Fagor Automation reserves the right to change the contents of this manual without prior notice.

All the trade marks appearing in the manual belong to the corresponding owners. The use of these marks by third parties for their own purpose could violate the rights of the owners.

It is possible that CNC can execute more functions than those described in its associated documentation; however, Fagor Automation does not guarantee the validity of those applications. Therefore, except under the express permission from Fagor Automation, any CNC application that is not described in the documentation must be considered as "impossible". In any case, Fagor Automation shall not be held responsible for any personal injuries or physical damage caused or suffered by the CNC if it is used in any way other than as explained in the related documentation.

The content of this manual and its validity for the product described here has been verified. Even so, involuntary errors are possible, hence no absolute match is guaranteed. However, the contents of this document are regularly checked and updated implementing the necessary corrections in a later edition. We appreciate your suggestions for improvement.

The examples described in this manual are for learning purposes. Before using them in industrial applications, they must be properly adapted making sure that the safety regulations are fully met.

INDEX

About the product - CNC 8070	7
Declaration of CE conformity and warranty conditions	11
Version history - CNC 8070	13
Safety conditions	17
Returning conditions	21
CNC maintenance	23

CHAPTER 1 PREVIOUS INFORMATION.

CHAPTER 2 CONFIGURATION.

2.1 Central unit.	27
2.2 Central unit + Monitor.	27
2.3 Central unit + Monitor + Keyboard and Operator panel.	28
2.4 Operator panels.	28
2.5 Keyboard.	29
2.6 Remote modules.	30
2.7 General diagram.	31

CHAPTER 3 HEAT DISSIPATION. CENTRAL UNIT (CPU) ENCLOSURE.

3.1 Heat dissipation models.	35
-----------------------------------	----

CHAPTER 4 C70-15 / C70-15T / C70-15A / C70-15AT C70-10K U70♦.

4.1 Models with an integrated monitor.	37
4.2 In-cabinet model.	38
4.3 Specifications.	39
4.4 Dimensions.	41
4.4.1 U70.	41
4.4.2 U70-M.	42
4.4.3 C70-10K.	43
4.4.4 C70-15 / C70-15T.	44
4.4.5 C70-15A / C70-15AT.	45
4.5 Enclosure and securing of models C70-10 / C70-15.	46
4.5.1 Ambient characteristics of the enclosure.	46
4.5.2 Enclosure design.	46
4.5.3 Securing the module.	48
4.6 Securing the U70 module ♦.	49
4.6.1 Ambient characteristics of the cabinet.	49
4.6.2 Cabinet design.	49
4.6.3 Ventilation.	49
4.7 Power supply for the module.	50
4.7.1 Voltage supply at 24 V DC.	51
4.7.2 Power supply with a Fagor battery.	51
4.7.3 Battery-powered RAM memory (non-volatile RAM).	52
4.7.4 Central unit protections.	52
4.8 Hardware functionality. Connectors.	53
4.8.1 Front of the monitor. USB connector.	53
4.8.2 Central unit. Peripheral board.	54
4.8.3 Central unit. Expansion board.	57
4.8.4 Central unit. CPU board.	60
4.8.5 PCI expansion board (only for the MCU model).	62
4.8.6 Handwheel connector (only for C70-10K).	64
4.9 Technical/electrical characteristics of the inputs and outputs.	65
4.9.1 Digital inputs.	65
4.9.2 Digital outputs.	65
4.9.3 Analog outputs.	65
4.9.4 Feedback inputs.	66
4.10 housing for the compact flash and battery-powered RAM memory.	67
4.11 Insert the board into the PCI expansion (only in MCU models).	68
4.12 Connections.	70

4.12.1	Probe connection.....	70
4.12.2	RS232 serial line connection.....	73
4.12.3	RS422 serial line connection.....	74
4.12.4	RS485 serial line connection.....	75
4.12.5	Feedback connection.....	76
4.12.6	Connection to an Ethernet network (Fast Ethernet).....	77

CHAPTER 5**LCD-15SVGA. PASSIVE MONITOR " LCD15-SVGA".**

5.1	Possible configurations.....	80
5.2	Technical characteristics.....	81
5.3	Hardware dimensions.....	82
5.4	Dimensions and characteristics of the enclosure.....	83
5.4.1	Enclosure design.....	83
5.4.2	Securing the module.....	84
5.5	Elements (connectors).....	85
5.6	Overall connection.....	87

CHAPTER 6**HORIZONTAL KEYB / HORIZONTAL KEYB+MOUSE.**

6.1	Specifications.....	89
6.2	General diagram.....	90
6.3	Dimensions.....	91
6.4	Enclosure and mounting of the module.....	92
6.4.1	Enclosure design.....	92
6.4.2	Securing the module.....	93
6.5	Hardware functionalities.....	94
6.5.1	Ground connection.....	94
6.5.2	Rear connectors.....	94

CHAPTER 7**VERTICAL KEYB / VERTICAL KEYB+MOUSE.**

7.1	Specifications.....	97
7.2	General diagram.....	98
7.3	Dimensions.....	99
7.4	Enclosure and mounting of the module.....	100
7.4.1	Enclosure design.....	100
7.4.2	Securing the module.....	101
7.5	Hardware functionalities.....	102
7.5.1	Ground connection.....	102
7.5.2	Rear connectors.....	102

CHAPTER 8**HORIZONTAL KEYB 2.0 + TOUCHPAD.**

8.1	Specifications.....	105
8.2	General diagram.....	106
8.3	Dimensions.....	107
8.4	Enclosure and mounting of the module.....	108
8.4.1	Enclosure design.....	108
8.4.2	Securing the module.....	109
8.5	Voltage supply for the module.....	110
8.6	Connectors.....	111
8.7	Selecting the language and the keyboard distribution.....	111
8.8	Using the Fagor logo key.....	113
8.9	Numeric keypad.....	113
8.10	Touchpad (touch screen).....	114

CHAPTER 9**OP-PANEL / OP-PANEL+SPDL RATE.**

9.1	Specifications.....	115
9.2	General diagram.....	116
9.3	Dimensions.....	117
9.4	Enclosure and mounting of the module.....	118
9.4.1	Enclosure design.....	118
9.4.2	Securing the module.....	119
9.5	Power supply for the module.....	120
9.6	Hardware functionalities.....	121
9.6.1	Ground connection.....	121
9.6.2	Rear connectors.....	121
9.7	Handwheel connection.....	125



FAGOR AUTOMATION

CNC 8070

(REF: 1709)

CHAPTER 10	MOUSE MODULE.	
	10.1 Especificaciones.	127
	10.2 Dimensions.	128
CHAPTER 11	EMERGENCY BATTERY.	
	11.1 Battery dimensions.	130
	11.2 Connectors and connection.	131
	11.3 Operation of the emergency battery.	132
CHAPTER 12	BUS CAN (CANFAGOR/CANOPEN PROTOCOLS).	
	12.1 Identification of the modules at the bus.	135
	12.2 Type of CAN bus and baudrate.	137
	12.3 Selecting the speed for the CANopen bus.	138
	12.4 Selecting the speed for the CANfagor bus.	140
CHAPTER 13	SERCOS-II BUS.	
	13.1 Module identification and connection.	143
	13.2 Data exchange via Sercos.	144
CHAPTER 14	MECHATROLINK BUS.	
CHAPTER 15	INSTALLING AND CONFIGURING A THIN CLIENT (EPATEC MODEL).	
	15.1 Install and configure the communication software at the CNC.	149
	15.2 Configuring the Thin Client.	151
	15.2.1 Configure the network protocol (for network or point-to point connection).	151
	15.2.2 Configure the communication between the CNC and the Thin Client.	152
	15.2.3 Configuring the startup of the Thin Client.	153
	15.2.4 Disable the mouse at the Thin Client.	154
CHAPTER 16	INSTALLING A SENSOR FOR GAP CONTROL (LASER MODEL).	



FAGOR AUTOMATION

CNC 8070

(REF: 1709)

BLANK PAGE

ABOUT THE PRODUCT - CNC 8070

BASIC CHARACTERISTICS.

Basic characteristics.	.BL.	.OL.	.L.
Number of axes.	3 to 7	3 to 31	3 to 31
Number of spindles.	1	1 to 6	1 to 6
Number of tool magazines.	1	1 to 4	1 to 4
Number of execution channels.	1	1 to 4	1 to 4
Number of interpolated axes (maximum).	4	3 to 31	3 to 31
Number of handwheels.	1 to 12		
Type of servo system.	Analog / Digital Sercos Digital Mechatrolink		Analog Sercos Digital
Communications.	RS485 / RS422 / RS232 Ethernet		
PCI expansion.	No	Option	No
Integrated PLC. PLC execution time. Digital inputs / Digital outputs. Marks / Registers. Timers / Counters. Symbols.	< 1ms/K 1024 / 1024 8192 / 1024 512 / 256 Unlimited		
Block processing time.	< 1 ms		< 1 ms

Remote modules.	RIOW	RIO5	RIO70	RIOR	RCS-S
Valid for CNC.	8070 8065 8060	8070 8065 8060	8070 8065 ---	8070 8065 8060	8070 8065 8060
Communication with the remote modules.	CANopen	CANopen	CANfagor	CANopen	Sercos
Digital inputs per module.	8	24 / 48	16	48	---
Digital outputs per module.	8	16 / 32	16	32	---
Analog inputs per module.	4	4	8	---	---
Analog outputs per module.	4	4	4	---	4
Inputs for PT100 temperature sensors.	2	2	---	---	---
Feedback inputs.	---	---	4 (*)	---	4 (**)

(*) Differential TTL / Sinusoidal 1 Vpp (**) TTL / Differential TTL / Sinusoidal 1 Vpp / SSI protocol / FeeDat / EnDat

Customizing.

PC-based open system, fully customizable.
INI configuration files.
Tool for display configuration FGUIM.
Visual Basic®, Visual C++®, etc.
Internal databases in Microsoft® Access.
OPC compatible interface

FAGOR 
FAGOR AUTOMATION

CNC 8070

(REF: 1709)

SOFTWARE OPTIONS.

Some of the features described in this manual are dependent on the acquired software options. The active software options for the CNC can be consulted in the diagnostics mode (accessible from the task window by pressing [CTRL] [A]), under software options.

Configuration	Software options													
	<table border="1"> <thead> <tr> <th>Options installed</th> </tr> </thead> <tbody> <tr><td>Number of channels: 1</td></tr> <tr><td>Number of axes: 4</td></tr> <tr><td>Number of interpolated axes: 4</td></tr> <tr><td>Number of spindles: 1</td></tr> <tr><td>Number of magazines: 1</td></tr> <tr><td>Y axis</td></tr> <tr><td>C axis</td></tr> <tr><td>Tandem axes</td></tr> <tr><td>Probe</td></tr> <tr><td>High speed machining II</td></tr> <tr><td>Digital SERCOS</td></tr> <tr><td>Conversational</td></tr> </tbody> </table>	Options installed	Number of channels: 1	Number of axes: 4	Number of interpolated axes: 4	Number of spindles: 1	Number of magazines: 1	Y axis	C axis	Tandem axes	Probe	High speed machining II	Digital SERCOS	Conversational
Options installed														
Number of channels: 1														
Number of axes: 4														
Number of interpolated axes: 4														
Number of spindles: 1														
Number of magazines: 1														
Y axis														
C axis														
Tandem axes														
Probe														
High speed machining II														
Digital SERCOS														
Conversational														

Consult the ordering handbook for information on the software options available for your model.

SOFT ADDIT AXES

Additional shaft.

Add axes to the default configuration.

SOFT ADDIT SPINDLES

Additional spindle.

Add spindles to the default configuration.

SOFT ADDIT TOOL MAGAZ

Additional tool magazine.

Add tool magazines to the default configuration.

SOFT ADDIT CHANNELS

Additional channel.

Add channels to the default configuration.

SOFT 4 AXES INTERPOLATION LIMIT

Limited to 4 interpolated axes.

It limits the number of axes to 4, where the CNC can also interpolate these at the same time.

SOFT OPEN SYSTEM

Open system.

The CNC is a closed system that offers all the features needed to machine parts. Nevertheless, at times there are some customers who use third-party applications to take measurements, perform statistics or other tasks apart from machining a part.

This feature must be active when installing this type of application, even if they are Office files. Once the application has been installed, it is recommended to close the CNC in order to prevent the operators from installing other kinds of applications that could slow the system down and affect the machining operations.

SOFT DIGITAL SERCOS

Sercos digital bus.

Sercos digital bus.

SOFT DIGIT NO FAGOR

Non-Fagor digital servo system.

Mechatrolink digital bus.

SOFT EDIT/SIMUL

EDISIMU mode (editing and simulation).

It allows for the editing, modification and simulation of a part-program.

SOFT IEC 61131 LANGUAGE

IEC 61131 language

IEC 61131 is a PLC programming language that is very popular in alternative markets, which is slowly entering into the machine-tool market. With this feature, the PLC may be programmed either in the usual Fagor language or in IEC 61131 format.

SOFT TOOL RADIUS COMP

Compensación de radio.

Tool compensation allows programming the contour to be machined based on part dimensions of the and without taking into account the dimensions of the tool that will be used later on. This avoids having to calculate and define the tool path based on the tool radius.

SOFT PROFILE EDITOR

Profile editor.

Allows for the part profiles to be edited graphically and to import dxf files.

SOFT RTCP

Dynamic RTCP (Rotating Tool Center Point).

The dynamic RTCP option is required for interpolation machining with 4, 5 or 6 axis.

SOFT C AXIS

C axis.

It activates the kinematics for working with the C axis and the associated canned cycles. The CNC can control several C axes. The parameters of each axis indicate if it will function as a C axis or not, where it will not be necessary to activate another axis for the machine parameters.

SOFT TANDEM AXES

Tandem axes.

A tandem axis consists in two motors mechanically coupled (slaved) and making up a single transmission system (axis or spindle). A tandem axis helps provide the necessary torque to move an axis when a single motor is not capable of supplying enough torque to do it.

When activating this feature, it should be kept in mind that for each tandem axis of the machine, another axis must be added to the entire configuration. For example, on a large 3-axis lathe (X Z and tailstock), if the tailstock is a tandem axis, the final purchase order for the machine must indicate 4 axes.

SOFT SYNCHRONISM

Synchronization of axes and spindles.

The axes and ballscrews may be synchronized in two ways: in terms of speed or position. The CNC configuration takes into consideration the synchronization of 2 axes or 2 spindles. Once synchronized, only the master displays and programs the element.

SOFT HSSA II MACHINING SYSTEM

HSSA-II machining system.

This is the new version of algorithms for high speed machining (HSC). This new HSSA algorithm allows for high speed machining optimization, where higher cutting speeds, smoother contours, a better surface finishing and greater precision are achieved.

SOFT TANGENTIAL CONTROL

Tangential control.

"Tangential Control" maintains a rotary axis always in the same orientation with respect to the programmed tool path. The machining path is defined on the axes of the active plane and the CNC maintains the orientation of the rotary axis along the entire tool path.

SOFT DRILL CYCL OL

Drilling ISO cycles for the OL model.

Drilling ISO cycles for the OL model (G80, G81, G82, G83).

SOFT PROBE

Probing canned cycles.

The CNC may have two probes; usually a tabletop probe to calibrate tools and a measuring probe to measure the part.

This option activates the functions G100, G103 and G104 (for probe movements); probe canned cycles are not included.

SOFT THIRD PARTY CANOPEN

Third-party CANopen.

Enables the use of non-Fagor CANopen modules.

SOFT FVC UP TO 10m3

SOFT FVC MORE TO 10m3

Medium and large volumetric compensation.

5-axis machines are generally used during the manufacturing of large parts. The accuracy of the parts is limited by the machine manufacturing tolerances and is affected by temperature variations during machining.

In sectors such as the aerospace industry, machining demands mean that classic compensation tools are becoming suboptimal. Volumetric compensation FVC comes in to complement the machine adjusting tools. When mapping the total work volume of the machine, the CNC knows the exact position of the tool at all times. After applying the required compensation, the resulting part is made with the desired precision and tolerance.

There are 2 choices, which depend on the size of the machine, being up to 10 m³ and over 10 m³.

SOFT 60 PWM CONTROL

Pulse-Width Modulation.

This function is only available for Sercos bus controlled systems. It is mostly oriented toward laser machines for the cutting of very thick sheets, where the CNC generates a series of PWM pulses to control the power of the laser when drilling the starting point.

This feature is essential for cutting very thick sheets and it requires two quick digital outputs located on the central unit. With this new feature, the OEM does not need to install or program any external device, which reduces machine costs and installation times. The end user also benefits, since the "Cutting with PWM" feature is much easier to use and program.

SOFT 60 GAP CONTROL

Gap control.

This is mostly oriented toward laser machines. Gap control makes it possible to maintain a set distance between the laser nozzle and the surface of the sheet. This distance is calculated by a sensor connected to the CNC, so that the CNC offsets the sensor variations on the distance programmed with additional movements in the axis programmed for the gap.

BLANK PAGE

DECLARATION OF CE CONFORMITY AND WARRANTY CONDITIONS

DECLARATION OF CONFORMITY

The declaration of conformity for the CNC is available in the downloads section of FAGOR'S corporate website. <http://www.fagorautomation.com>. (Type of file: Declaration of conformity).

WARRANTY TERMS

The warranty conditions for the CNC are available in the downloads section of FAGOR's corporate website. <http://www.fagorautomation.com>. (Type of file: General sales-warranty conditions).



FAGOR AUTOMATION

CNC 8070

(REF: 1709)

BLANK PAGE

VERSION HISTORY - CNC 8070

Here is a list of the features added to each manual reference.

Ref. 0601

The PCI central unit is removed from the manual.
New monitor LCD-15".

Ref. 0609

The floppy disk unit with USB connectors is removed from the manual.
Remote modules (bus CAN with CANopen protocol).

Ref. 0705

ICU central unit.
MCU central unit.
15" passive screen.

Ref. 0706

Corrected the numbering of the pinout of "Phoenix Contact" connectors

Ref. 0710 / Ref. 0801

The handwheel module with the E-stop button has been removed from the manual.

Ref. 0804

Corrected mouse dimensions.

Ref. 0809

The PC104 central unit is removed from the manual.
The VGA cable for passive screens is valid for cable carrying chains.
The remote modules with CANopen are now called RIO5 remote modules.
The remote modules with CANfagor are now called RIO70 remote modules.
New RIO70 remote modules.

Ref. 0907

Corrected errors. Remote modules RIO70 and RIO5 cannot handle a probe.
RS485 pinout correction.
Mechatrolink bus.
PCI expansion module for MCU central unit.



FAGOR AUTOMATION

CNC 8070

(REF: 1709)

Ref. 1007

Corrected errors. Position of the dip-switches for selecting the speed in the CAN bus with CANopen protocol, in the OP-PANEL-HE and Jog-Panel.
RIOW remote modules. The name of the RIOW-CANOPEN has been changed to RIOW-CANOPEN-ECO.
RIOW remote modules. New module RIOW-CANOPEN-STAND.
ICU - MCU central unit. Configure the serial line as RS232, RS422 or RS485.
RS485. At the line terminating resistor, pin 2 must NOT be jumpered with pins 7/9 nor pin 3 with pins 6/8.
Thin Client.

Ref. 1304

Corrected the characteristics of the feedback inputs of the central unit.
The RIO70 remote modules are now Class III. New protection considerations about electrical choques.
Change the CN371 battery.
Corrected the protection degree of the front panel of the central unit; IP 65.
New model LCD-10K.
New keyboard VERTICAL-KEYB.
New keyboard HORIZONTAL-KEYB.
New operator panel OP-PANEL.

Ref. 1309

Hardware.
<ul style="list-style-type: none"> The LCD-10 model has been eliminated. The LCD-10K model (front mounting) has been eliminated. The LCD-15 model (front mounting) has been eliminated. The OP-PANEL-H/E module has been eliminated. The JOG-PANEL module has been eliminated. The KB-PANEL-H module has been eliminated.
The remote modules have been eliminated. New manual.

Ref. 1404

15" passive screen.
New dimensions of the central unit with LCD-15 monitor.
New dimensions of the central unit with LCD-10K monitor.
Work temperature: 0-45 °C.

Ref. 1405

Corrected the handwheel connector (X11) of the central unit with LCD-10K monitor.

Ref. 1408

Central unit with LCD-15 monitor. Corrected dimensions of the enclosure.
Central unit with LCD-10K monitor. Corrected dimensions of the enclosure.
New peripheral board, with 4 USB.
Corrected the protection degree of the front panel of the central unit; IP 65.

Ref. 1512

Módulo OP-PANEL. Feedback cable connection to the ground plate of the electrical cabinet.

Ref. 1703

Laser model.
<ul style="list-style-type: none"> Installing a sensor for gap control (laser model).
LCD 15" SVGA passive monitor. - DISCONTINUED -.

Ref. 1709

New. HORIZONTAL KEYB 2.0 + TOUCHPAD.



BLANK PAGE

SAFETY CONDITIONS

Read the following safety measures in order to prevent harming people or damage to this product and those products connected to it. Fagor Automation shall not be held responsible of any physical or material damage originated from not complying with these basic safety rules.



Before start-up, verify that the machine that integrates this CNC meets the 2006/42/EC Directive.

PRECAUTIONS BEFORE CLEANING THE UNIT

- Do not get into the inside of the unit.** Only personnel authorized by Fagor Automation may access the interior of this unit.
- Do not handle the connectors with the unit connected to AC power.** Before handling these connectors (I/O, feedback, etc.), make sure that the unit is not powered.

PRECAUTIONS DURING REPAIRS

In case of a malfunction or failure, disconnect it and call the technical service.

- Do not get into the inside of the unit.** Only personnel authorized by Fagor Automation may access the interior of this unit.
- Do not handle the connectors with the unit connected to AC power.** Before handling these connectors (I/O, feedback, etc.), make sure that the unit is not powered.

PRECAUTIONS AGAINST PERSONAL HARM

- Interconnection of modules.** Use the connection cables provided with the unit.
- Use proper cables.** To prevent risks, only use cables and Sercos fiber recommended for this unit.
To prevent a risk of electrical shock at the central unit, use the proper connector (supplied by Fagor); use a three-prong power cable (one of them being ground).
- Avoid electric shocks.** To prevent electrical shock and fire risk, do not apply electrical voltage out of the indicated range.
- Ground connection.** In order to avoid electrical discharges, connect the ground terminals of all the modules to the main ground terminal. Also, before connecting the inputs and outputs of this product, make sure that the ground connection has been done.
In order to avoid electrical shock, before turning the unit on verify that the ground connection is properly made.
- Do not work in humid environments.** In order to avoid electrical discharges, always work with a relative humidity (non-condensing).
- Do not work in explosive environments.** In order to avoid risks, harm or damages, do not work in explosive environments.

FAGOR 

FAGOR AUTOMATION

CNC 8070

(REF: 1709)

PRECAUTIONS AGAINST DAMAGE TO THE PRODUCT

Work environment.	This unit is ready to be used in industrial environments complying with the directives and regulations effective in the European Community. Fagor Automation shall not be held responsible for any damage suffered or caused by the CNC when installed in other environments (residential, homes, etc.).
Install this unit in the proper place.	It is recommended, whenever possible, to install the CNC away from coolants, chemical product, blows, etc. that could damage it. This unit meets the European directives on electromagnetic compatibility. Nevertheless, it is recommended to keep it away from sources of electromagnetic disturbance such as: <ul style="list-style-type: none"> Powerful loads connected to the same mains as the unit. Nearby portable transmitters (radio-telephones, Ham radio transmitters). Nearby radio / TC transmitters. Nearby arc welding machines. Nearby high voltage lines.
Enclosures.	It is up to the manufacturer to guarantee that the enclosure where the unit has been installed meets all the relevant directives of the European Union.
Avoid disturbances coming from the machine.	The machine must have all the interference generating elements (relay coils, contactors, motors, etc.) uncoupled.
Use the proper power supply.	Use an external regulated 24 Vdc power supply for the keyboard, operator panel and the remote modules.
Connecting the power supply to ground.	The zero Volt point of the external power supply must be connected to the main ground point of the machine.
Analog inputs and outputs connection.	Use shielded cables connecting all their meshes to the corresponding pin.
Ambient conditions.	Maintain the CNC within the recommended temperature range, both when running and not running. See the corresponding chapter in the hardware manual.
Central unit enclosure.	To maintain the right ambient conditions in the enclosure of the central unit, it must meet the requirements indicated by Fagor. See the corresponding chapter in the hardware manual.
Power switch.	This switch must be easy to access and at a distance between 0.7 and 1.7 m (2.3 and 5.6 ft) off the floor.

SAFETY SYMBOLS

Symbols that may appear in the manual.



Danger or prohibition symbol.
This symbol indicates actions or operations that may hurt people or damage products.



Warning or caution symbol.
This symbol indicates situations that certain operations could cause and the suggested actions to prevent them.



Obligation symbol.
This symbol indicates actions and operations that must be carried out.



Information symbol.
This symbol indicates notes, warnings and advises.



Symbol for additional documentation.
This symbol indicates that there is another document with more detailed and specific information.

Hardware configuration.

Symbols that the product may carry.



*Ground symbol.
This symbol indicates that that point must be under voltage.*



*ESD components.
This symbol identifies the cards as ESD components (sensitive to electrostatic discharges).*



BLANK PAGE

RETURNING CONDITIONS

Pack it in its original package along with its original packaging material. If you do not have the original packaging material, pack it as follows:

- 1 Get a cardboard box whose 3 inside dimensions are at least 15 cm (6 inches) larger than those of the unit itself. The cardboard being used to make the box must have a resistance of 170 Kg (375 lb.).
- 2 Attach a label to the device indicating the owner of the device along with contact information (address, telephone number, email, name of the person to contact, type of device, serial number, etc.). In case of malfunction also indicate symptom and a brief description of the problem.
- 3 Protect the unit wrapping it up with a roll of polyethylene or with similar material. When sending a central unit with monitor, protect especially the screen.
- 4 Pad the unit inside the cardboard box with polyurethane foam on all sides.
- 5 Seal the cardboard box with packaging tape or with industrial staples.

FAGOR 

FAGOR AUTOMATION

CNC 8070

(REF: 1709)

BLANK PAGE

CNC MAINTENANCE

CLEANING

The accumulated dirt inside the unit may act as a screen preventing the proper dissipation of the heat generated by the internal circuitry which could result in a harmful overheating of the unit and, consequently, possible malfunctions. Accumulated dirt can sometimes act as an electrical conductor and short-circuit the internal circuitry, especially under high humidity conditions.

To clean the operator panel and the monitor, a smooth cloth should be used which has been dipped into de-ionized water and /or non abrasive dish-washer soap (liquid, never powder) or 75° alcohol. Never use air compressed at high pressure to clean the unit because it could cause the accumulation of electrostatic charges that could result in electrostatic shocks.

The plastics used on the front panel are resistant to grease and mineral oils, bases and bleach, dissolved detergents and alcohol. Avoid the action of solvents such as chlorine hydrocarbons, benzole, esters and ether which can damage the plastics used to make the unit's front panel.

PRECAUTIONS BEFORE CLEANING THE UNIT

Fagor Automation shall not be held responsible for any material or physical damage derived from the violation of these basic safety requirements.

- Do not handle the connectors with the unit supplied with power. Before handling these connectors (I/O, feedback, etc.), make sure that the unit is not powered.
- Do not get into the inside of the unit. Only personnel authorized by Fagor Automation may access the interior of this unit.

BLANK PAGE

1 PREVIOUS INFORMATION.

About this manual.

This manual describes the characteristics, technical data and connections of the hardware associated with the CNC. The installation manual describes the CNC configuration, machine adaptation and start-up.

Installation and startup.

The hardware described in this manual is ready to be used in industrial environments complying with the directives and regulations effective in the European Community. Before start-up, verify that the machine that integrates this CNC meets the 89/392/CEE directive.

Safety conditions.

In order to avoid personal injuries and damage to this product or to those connected to it, read carefully the section on safety conditions in the introduction to this manual. Fagor Automation shall not be held responsible of any physical damage or defective unit resulting from not complying with these basic safety regulations.



Do not handle the connectors with the unit connected to AC power. Before doing it, make sure that the unit is unplugged from the power outlet.



Do not get into the inside of the unit. This unit MUST NOT be opened by unauthorized personnel. Only personnel authorized by Fagor Automation may manipulate the inside of this unit.

1.

PREVIOUS INFORMATION.

FAGOR 

FAGOR AUTOMATION

CNC 8070

(REF: 1709)

1.

PREVIOUS INFORMATION.



FAGOR AUTOMATION

CNC 8070

(REF: 1709)

2 CONFIGURATION.

2.1 Central unit.

Identification.	Description.
 <p>U70□</p>	<ul style="list-style-type: none"> • In-cabinet Central Unit • Connecting to a VGA monitor. • Connecting to keyboards and operator panels via the CAN.

2.2 Central unit + Monitor.

The central unit is located on the rear of the monitor.

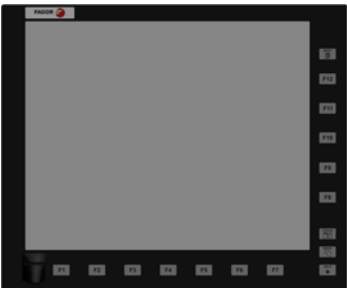
Identification.	Description.
 <p>C70-15 C70-15T (discontinued)</p>	<ul style="list-style-type: none"> • The central unit is located on the rear of the monitor. • 15" (1024 × 768 pixels) monitor, aspect ratio 4:3, 24-bit color. • USB 2.0 port, at the front, protected by a cover. • Touch screen (only C65□-15T).
 <p>C70-15A C70-15AT</p>	<ul style="list-style-type: none"> • The central unit is located on the rear of the monitor. • 15" (1920 × 1080 pixels) monitor, aspect ratio 4:3, 24-bit color. • USB 2.0 port, at the front, protected by a cover. • Capacitive multi-touch screen, optimized for the machine tool sector, including work using gloves typically found in the sector. (only C65□-15AT).

2.
 CONFIGURATION.

2.3 Central unit + Monitor + Keyboard and Operator panel.



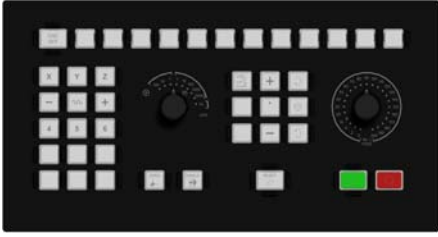
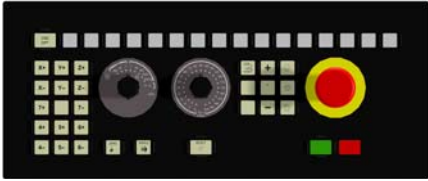
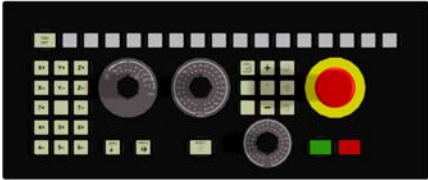

The central unit is located on the rear of the monitor.

Identification.	Description.
 <p>C70-10K</p>	<ul style="list-style-type: none"> • Central unit. • 10.4" LCD monitor (800x600) 18-bit color. • Built-in keyboard. • Built-in operator panel. • USB 2.0 port, at the front, protected by a cover.

2.4 Operator panels.

Identification.	Description.
 <p>OP-PANEL-329</p>	<p>Available for all models.</p> <ul style="list-style-type: none"> • Length 329 mm (12.95"). • 12 configurable user keys. • Jog switch (0 - 200 %). • 15 configurable jog keys. • CNC power-down key. • CAN communication (CANopen protocol). • Spindle override key. • Possibility to connect up to three handwheels.
 <p>OP-PANEL</p>	<p>Available for all models.</p> <ul style="list-style-type: none"> • Length 420 mm (16.54") • 16 configurable user keys. • Jog switch (0 - 200 %). • 15 configurable jog keys. • CNC power-down key. • CAN communication (CANopen protocol). • Spindle override key. • Possibility to connect up to three handwheels.
 <p>OP-PANEL+SPDL RATE</p>	<p>Available for all models.</p> <ul style="list-style-type: none"> • Length 420 mm (16.54") • 16 configurable user keys. • Jog switch (0 - 200 %). • 15 configurable jog keys. • CNC power-down key. • CAN communication (CANopen protocol). • Spindle override switch. • Possibility to connect up to three handwheels.

2.5 Keyboard.

Identification.	Description.
 <p>HORIZONTAL KEYB 2.0 + TOUCHPAD.</p>	<ul style="list-style-type: none"> • USB horizontal, alphanumeric QWERTY keyboard. • Multi-touch touchpad (touch panel). • Numeric keypad optimized to operate with the CNC (keys for axes, feedrate, speed, etc). • Special functions with the Fagor key.
 <p>HORIZONTAL KEYB</p>	<ul style="list-style-type: none"> • CAN horizontal, alphanumeric QWERTY keyboard.
 <p>HORIZONTAL KEYB+MOUSE</p>	<ul style="list-style-type: none"> • CAN horizontal, alphanumeric QWERTY keyboard. • Mouse.
 <p>VERTICAL KEYB</p>	<ul style="list-style-type: none"> • Vertical CAN QWERTY keyboard.
 <p>VERTICAL KEYB+MOUSE</p>	<ul style="list-style-type: none"> • Vertical CAN QWERTY keyboard. • Mouse.

2.

CONFIGURATION.

FAGOR 





FAGOR AUTOMATION

CNC 8070

(REF: 1709)

2.6 Remote modules.

Remote modules may be used to have extra resources (see table below) distributed at different locations of the machine or installed in the electrical cabinet.

Identification.	Description.
 <p>RIO5 series</p>	<ul style="list-style-type: none"> • CAN communication (CANopen protocol). • Digital inputs and outputs. • Analog inputs and outputs. • Analog inputs for PT100 temperature sensors.
 <p>RIOW series</p>	<ul style="list-style-type: none"> • CAN communication (CANopen protocol). • Digital inputs and outputs. • Analog inputs and outputs. • Analog inputs for PT100 temperature sensors.
 <p>RIOR series</p>	<ul style="list-style-type: none"> • CAN communication (CANopen protocol). • Digital inputs and outputs. • Analog inputs and outputs (configurable to voltage or current). • Analog inputs for PT100 temperature sensors.
 <p>RCS-S Series</p>	<ul style="list-style-type: none"> • Sercos II communication. • Feedback inputs. • Analog outputs.

2.

CONFIGURATION.



FAGOR AUTOMATION

CNC 8070

(REF: 1709)

2.7 General diagram.

See the schematic description of all the elements that make up the CNC system:

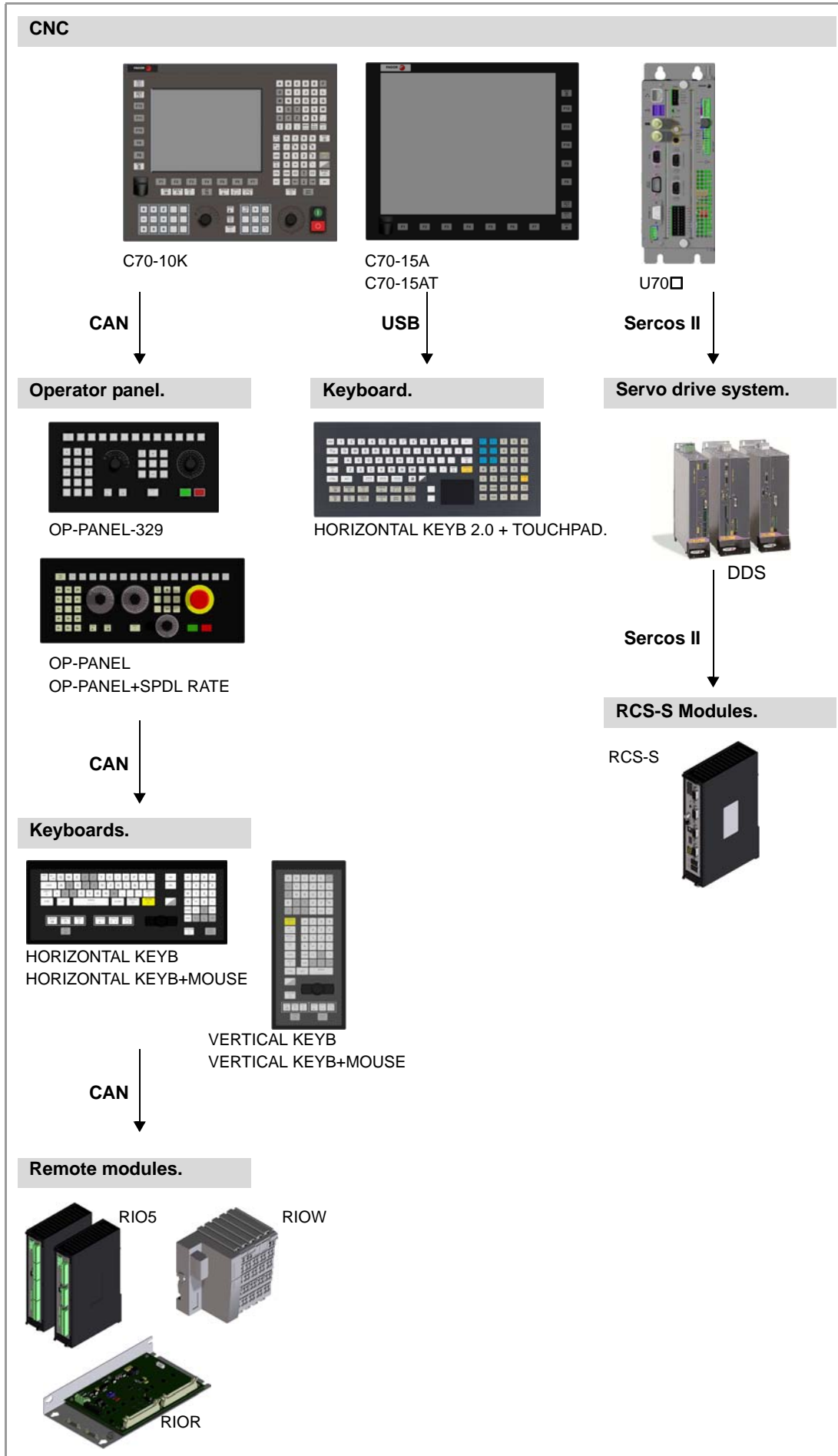

2.

CONFIGURATION.

2.

CONFIGURATION.



FAGOR AUTOMATION

CNC 8070

(REF: 1709)

3 HEAT DISSIPATION. CENTRAL UNIT (CPU) ENCLOSURE.

The enclosure must be designed to ensure an ambient temperature of 45 °C (113 °F) and while the unit is running, the enclosure temperature must not exceed 55 °C (131 °F). To ensure that it does not exceed this temperature, the enclosure must meet the following requirements.

- The enclosure must have enough surface inside to evacuate the heat generated inside and keep the ambient conditions within the working temperature range.
- The enclosure must respect the minimum distances recommended between the enclosure walls and the central unit to let the air flow and improve heat dissipation.

Minimum gaps recommended between the enclosure walls and the central unit.

To ensure that it does not exceed this temperature, respect the recommended minimum gap between the sides of the enclosure and the central unit.

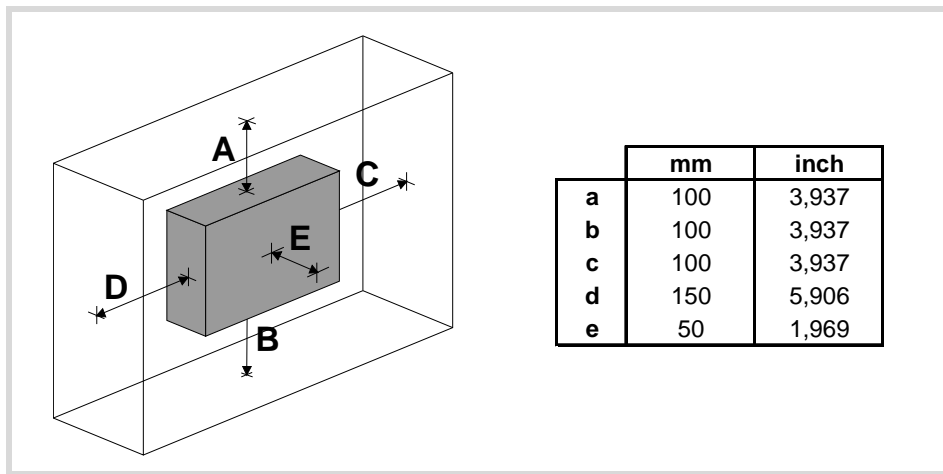

To ensure the required ambient conditions, the enclosure must have an air input next to the cables and an air output next to the fan. In this case, install fans to ventilate the enclosure and keep the temperature within the allowed limits.

Keep the enclosure clean. Anti-dust filters should be installed at the air inputs and outputs.

Understanding the calculation of the surface needed for heat dissipation

The expressions have been obtained for an enclosure having a 2 mm wall and made out of aluminum. When using internal ventilation, the fan must be located 30 mm off the bottom.

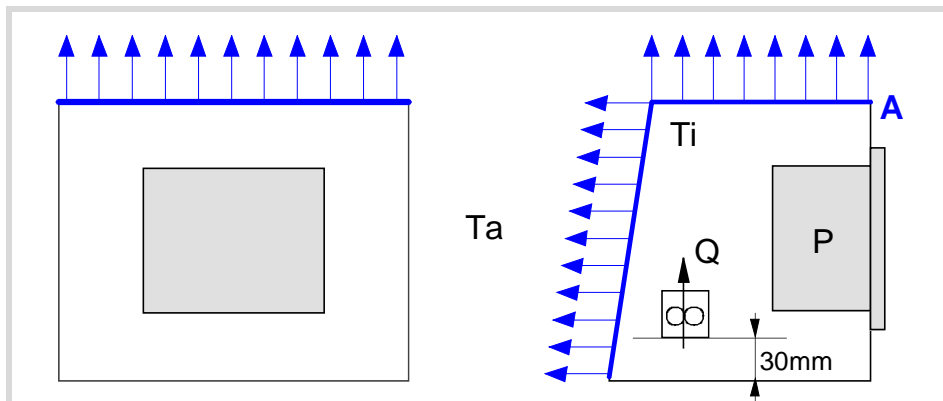

3.

HEAT DISSIPATION. CENTRAL UNIT (CPU) ENCLOSURE.

To calculate the total surface required for the enclosure, in order to dissipate the heat generated in it, the following data must be considered.

Data	Units	Meaning
A	(m ²)	Total surface needed.
P	(W)	Total power dissipated by all the elements that generate heat inside the enclosure, including the power supply and the fan, if there is one.
Ta	(°C)	Ambient temperature (outside the enclosure).
Ti	(°C)	Temperature inside the enclosure.
Δt	(°C)	Temperature difference (Ti-Ta).
Q	(m ³ /h)	Air flow provided by the fan, if there is one.

Dissipating surface.

Only surfaces dissipating heat by convection will be considered, the top and the rear of the enclosure. The rest of the surfaces are not to be considered when calculating the total surface.

Power dissipated by the CNC.

To calculate the dissipated power, all the elements that are inside the enclosure must be taken into account.

Element	Dissipated power
ICU central unit.	85 watts.

3.

HEAT DISSIPATION. CENTRAL UNIT (CPU) ENCLOSURE.



FAGOR AUTOMATION

CNC 8070

(REF: 1709)

3.1 Heat dissipation models.

Heat dissipation by natural convection.

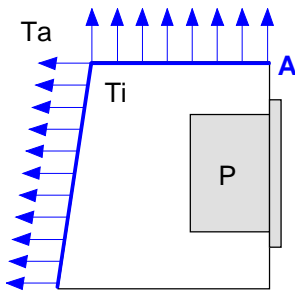

Unpainted surface.

$$A = \frac{P}{5 \cdot \Delta T}$$

Surface with smooth metallic enamel.

$$A = \frac{P}{5,7 \cdot \Delta T}$$

Heat dissipation by forced convection with internal fan.

Fan whose air flow Q = 13.6 m³/h facing down.

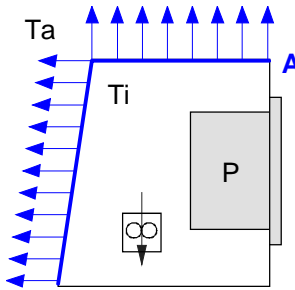

Unpainted surface.

$$A = \frac{P}{5,6 \cdot \Delta T}$$

Surface with smooth metallic enamel.

$$A = \frac{P}{7,6 \cdot \Delta T}$$

Fan whose air flow Q = 13.6 m³/h facing up.

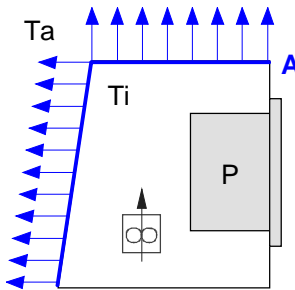

Unpainted surface.

$$A = \frac{P}{5,8 \cdot \Delta T}$$

Fan whose air flow Q = 30 m³/h facing down.

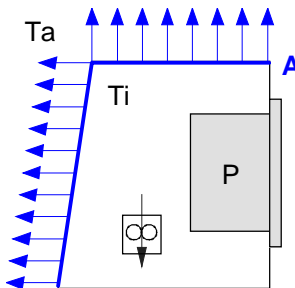

Unpainted surface.

$$A = \frac{P}{6,75 \cdot \Delta T}$$

Surface with smooth metallic enamel.

$$A = \frac{P}{9,1 \cdot \Delta T}$$

3.

HEAT DISSIPATION. CENTRAL UNIT (CPU) ENCLOSURE.

FAGOR 

FAGOR AUTOMATION

CNC 8070

(REF: 1709)

Fan whose air flow $Q = 102 \text{ m}^3/\text{h}$ facing down.

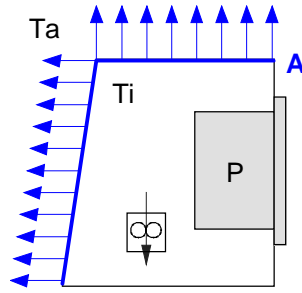

Unpainted surface.

$$A = \frac{P}{7,5 \cdot \Delta T}$$

Surface with smooth metallic enamel.

$$A = \frac{P}{9,8 \cdot \Delta T}$$

Heat dissipation by air flow to the outside using a fan.

Heat dissipation by forced convection with hot air flow to the outside using a fan and ambient air intake through the holes located at the bottom of the enclosure.

For this case, the volume of air flow is calculated necessary to evacuate the heat generated inside the enclosure. The fan's air flow is calculated according to the power dissipated by the CNC and the fan itself as well as the inside and outside temperatures.

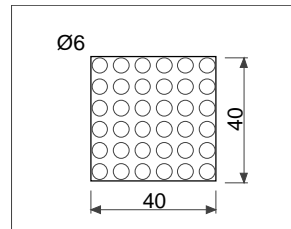

Unpainted surface.

$$V = \frac{3,8 \cdot P}{\Delta T}$$

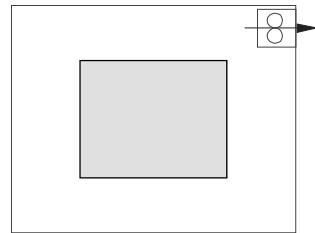

Bear in mind that this air flow through the unit extracts hot air to the outside, but it allows dirt into the enclosure. Thus, a filter should be installed to maintain the ambient conditions allowed.

4 C70-15 / C70-15T / C70-15A / C70-15AT C70-10K U70□.

4.1 Models with an integrated monitor.

Module.	Differences.
C70-15 C70-15T (discontinued)	<ul style="list-style-type: none"> The central unit is located on the rear of the monitor. 15" (1024 × 768 pixels) monitor, aspect ratio 4:3, 24-bit color. USB 2.0 port, at the front, protected by a cover. Touch screen (C70-15T).
C70-15A	<ul style="list-style-type: none"> 15" (1920 × 1080 pixels) monitor, aspect ratio 4:3, 24-bit color. USB 2.0 port, at the front, protected by a cover.
C70-15AT	<ul style="list-style-type: none"> 15" (1920 × 1080 pixels) monitor, aspect ratio 4:3, 24-bit color. USB 2.0 port, at the front, protected by a cover. Capacitive multi-touch screen, optimized for the machine tool sector, including work with gloves typically found in the sector.
C70-10K	<ul style="list-style-type: none"> The central unit is located on the rear of the monitor. 10.4" (800 × 600 pixels) LCD monitor, aspect ratio 4:3, 18-bit color. Keyboard and operator panel. USB 2.0 port, at the front, protected by a cover.

CNC consisting of a 10 or 15" monitor, a central unit attached to the back and an accessible USB 2.0 port on the front, protected by a cover.

C70-15 / C70-15A / C70-15T / C70-15AT

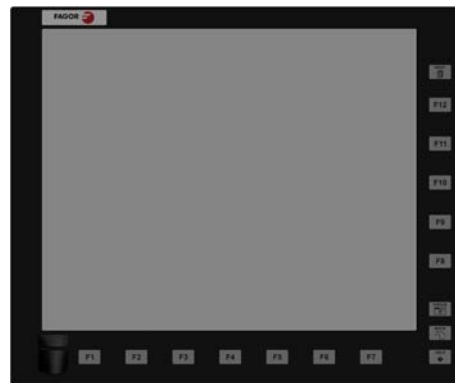

C70-10K



4.

C70-15 / C70-15T / C70-15A / C70-15AT C70-10K U70♦.

FAGOR 

FAGOR AUTOMATION

CNC 8070

(REF: 1709)

4.2 In-cabinet model.

Available for 8065 and 8065 Power models.

Module.	Differences.
U70□	<ul style="list-style-type: none"> In-cabinet Central Unit Connecting to a VGA monitor. Connecting to keyboards and operator panels via the CAN.

U70□

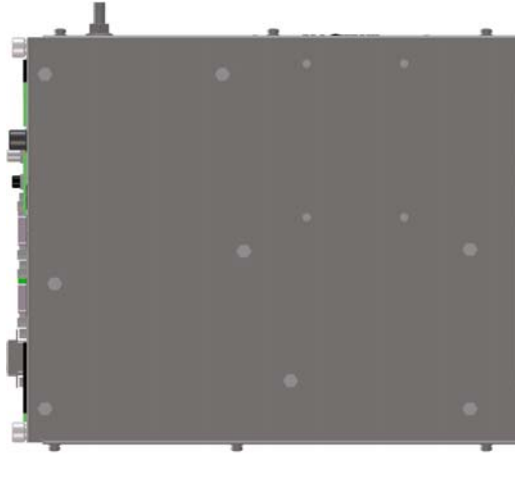

4.

C70-15 / C70-15T / C70-15A / C70-15AT / C70-10K U70♦.

4.3 Specifications.

Type.	Description.
General.	<ul style="list-style-type: none"> • Monitor set with the central unit attached on the rear. The CN70-10K model also comes with a keyboard and operator panel. • Touch screen (models C70-15T / C70-15AT). • USB 2.0 port, at the front, protected by a cover. • Dimensions of C70-15 / C70-15T (width x height x depth). <ul style="list-style-type: none"> - 420 x 350 x 124 mm. - 16.54" x 13.78" x 4.88". • Dimensions of C70-15A / C70-15AT (width x height x depth). <ul style="list-style-type: none"> - 420 x 350 x 124 mm. - 16.54" x 13.78" x 4.88". • Dimensions of C70-10K (width x height x depth). <ul style="list-style-type: none"> - 420 x 350 x 126 mm. - 16.54" x 13.78" x 4.96". • Dimensions of U70□ (width x height x depth). <ul style="list-style-type: none"> - 90 x 250.3 x 254 mm. - 3.54" x 9.85" x 10.00".
System.	<ul style="list-style-type: none"> • Choice of processor. <ul style="list-style-type: none"> - Processor: Pentium M 1.1 GHz. - Processor: T56N Mono Core 1.6 GHz. - Processor: T56N Dual Core 1.6 GHz (only for model OL). • RAM memory. <ul style="list-style-type: none"> - 1 GB (model BL). - 2 GB (model OL). • Storage. <ul style="list-style-type: none"> - 2 GB CompactFlash (model BL). - CompactFlash de 4 o 32 GB (model OL). • RAM memory with battery. • CMOS battery accessible from the outside, CR2450 / CN371 (depending on the CNC model). • Choice of OS image: <ul style="list-style-type: none"> - Windows7A (C70-15AT multi-touch) - Windows7 (C70-10K / C70-15A / C70-15AT single-touch). - WindowsXP (C70-10K / C70-15A / C70-15AT single-touch).
LCD.	<ul style="list-style-type: none"> • C70-15 / C70-15T. <ul style="list-style-type: none"> - Type: TFT LCD. - Screen: Touch-screen. - Size: 15" (aspect ratio 4:3). - Resolution: 1024 x 768 pixels. • C70-15A / C70-15AT. <ul style="list-style-type: none"> - Type: TFT LCD. - Screen: Capacitive multi-touch (projected capacitive). - Size: 15" (aspect ratio 4:3). - Resolution: 1920 x 1080 pixels. • C70-10K. <ul style="list-style-type: none"> - Type: TFT LCD. - Size: 10.4" (aspect ratio 4:3). - Resolution: 800 x 600 pixels. • U70□. <ul style="list-style-type: none"> - Without monitor.
Regulation.	<ul style="list-style-type: none"> • CE.
Packaging.	<ul style="list-style-type: none"> • Meets EN 60068-2-32 standard. • Free fall packaged according to Fagor regulations (1 meter):
Ambient.	<ul style="list-style-type: none"> • Operating temperature: -40 ~ 70 °C (-40 ~ 158 °F). • Working temperature: 0 ~ 45 °C, with a mean of 35 °C. (32 ~ 113 °F, with a mean of 95 °F). • Relative humidity: 20 ~ 85 % RH (without condensation). • Maximum work altitude: Meets the "IEC 1131-2" standard. • Vibration: Sweep sine trial with a frequency step of 1 octave/minute (±10 %) and 10 sweeps long. <ul style="list-style-type: none"> - 9 Hz ≥ f ≥ 5 Hz; Constant movement with an amplitude of 3 mm. - 200 Hz ≥ f ≥ 9 Hz; constant acceleration of 1g. • Degree of protection: IP65 (front), IP20 (rear).

4.

C70-15 / C70-15T / C70-15A / C70-15AT C70-10K U70♦.

FAGOR

FAGOR AUTOMATION

CNC 8070

(REF: 1709)

4.

C70-15 / C70-15T / C70-15A / C70-15AT / C70-10K U70♦.

Type.	Description.
Power supply.	<ul style="list-style-type: none"> Supply voltage: 24 V DC \pm10 % and 3.5 A. Current peak of 90 A on power-up. Consumption: 85 W (maximum).
Connectivity.	<p>Monitor.</p> <ul style="list-style-type: none"> 1 USB 2.0 port, accessible at the front, protected by a cover. <p>Central unit.</p> <ul style="list-style-type: none"> 2 USB 1.1 ports (model with a Pentium M processor). 4 USB 2.0 ports (models with a T56N processor). 1 RS-232/422/485 (115 kbps) serial port. 1 LAN RJ45 port for Ethernet 10/100BaseT network. 1 VGA output. CAN Bus (CANfagor/CANopen). Sercos II bus (optional). Mechatrolink bus (optional). Mouse with PS-2 connector (model with Pentium M processor).
Inputs/outputs.	<ul style="list-style-type: none"> 8 digital inputs and 8 digital inputs or outputs (configurable). <ul style="list-style-type: none"> Digital inputs: 24 V DC, 5 mA (typical consumption). Digital outputs: 24 V DC, 500 mA. <ul style="list-style-type: none"> ON cycle: minimum 75 μs (25 μs, optional in two of them). 2 feedback inputs (5 V 0.250 A). <ul style="list-style-type: none"> Incremental differential TTL or differential TTL signal. Frequency : 100 kHz (TTL) / 1000 kHz (TTL differential). 1 emergency relay with two normally open contacts (1 A at 24 V). 2 probe inputs (5 V or 24 V) 1 input for three handwheels with A and B signals (5 V DC TTL) (only C70-10K).

The machine manufacturer must comply with the EN 60204-1 (IEC-204-1) regulation regarding electrical shocks in case of defective input/output pins with external power supply when not plugging the connector before turning the power supply on.



*Do not get into the inside of the unit. This unit **MUST NOT** be opened by unauthorized personnel. Only personnel authorized by Fagor Automation may access the interior of this unit.*



Fagor Automation offers several flash compact in its catalog to increase storage space; if you are going to use other compact flashes, always use industrial grade compact flash SLC; they support temperatures between -40°C and +80°C (-40°F and 176°F) and last 27 years with 1000 writes per day. Fagor Automation shall not be held responsible for any problems caused by using other lower-quality compact flash.



No USB devices must be used nor connected while executing a part program. Using USB devices may slow down the execution or cause some "RT-IT overflow" type error.



DO NOT connect any kind of hub to the USB port.



FAGOR AUTOMATION

CNC 8070

(REF: 1709)

4.4 Dimensions.

4.4.1 U70.

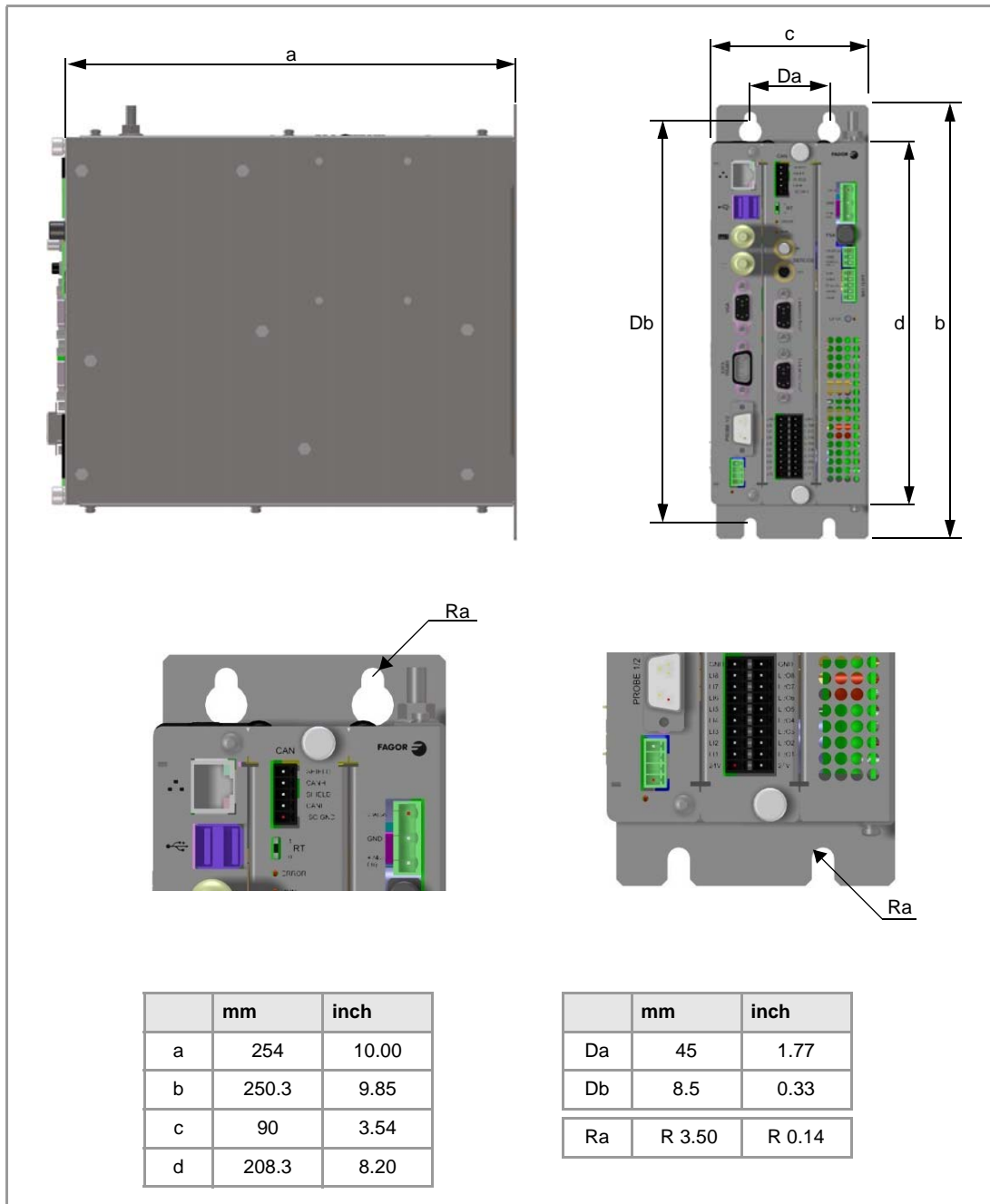

4.

C70-15 / C70-15T / C70-15A / C70-15AT / C70-10K U70♦.

FAGOR 

FAGOR AUTOMATION

CNC 8070

(REF: 1709)

4.4.2 U70-M.

4.

C70-15 / C70-15T / C70-15A / C70-15AT C70-10K U70♦.

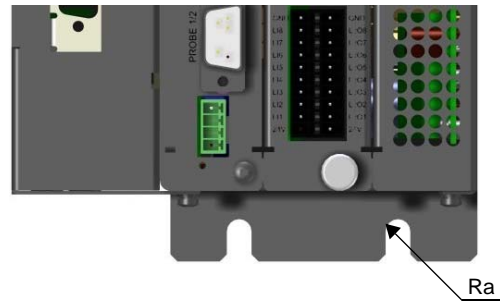
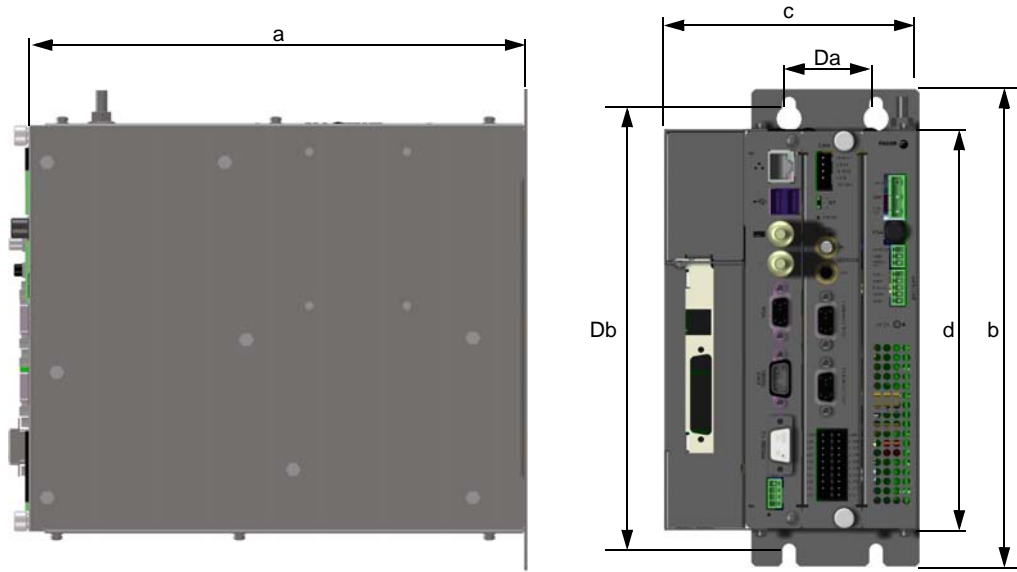

	mm	inch
a	254	10.00
b	250.3	9.85
c	132	5.20
d	208.3	8.20

	mm	inch
Da	45	1.77
Db	8.5	0.33
Ra	R 3.50	R 0.14

4.4.3 C70-10K.

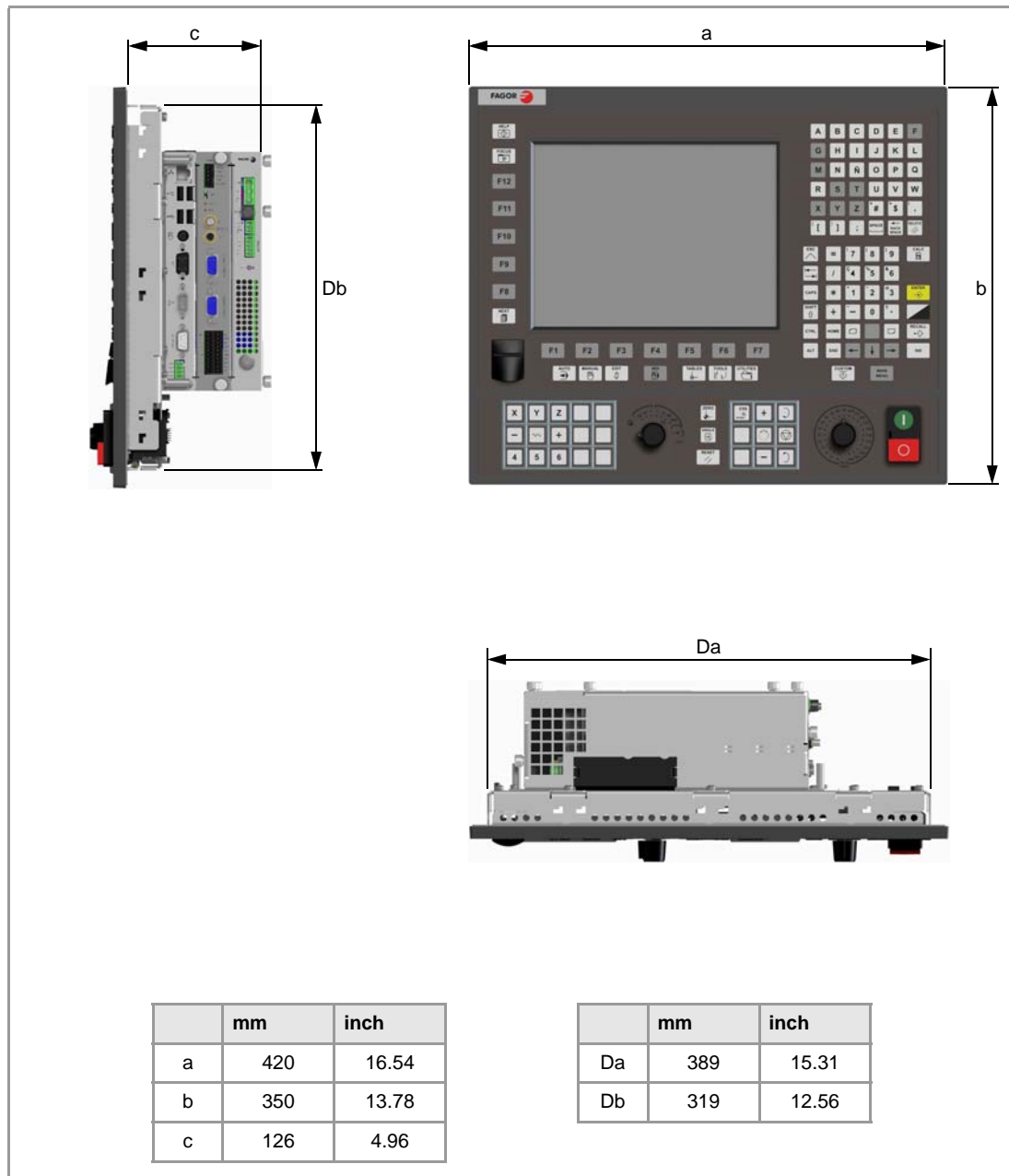

4.

C70-15 / C70-15T / C70-15A / C70-15AT / C70-10K U70♦.



FAGOR AUTOMATION

CNC 8070

(REF: 1709)

4.4.4 C70-15 / C70-15T.



DISCONTINUED



4.

C70-15 / C70-15T / C70-15A / C70-15AT C70-10K U70♦.

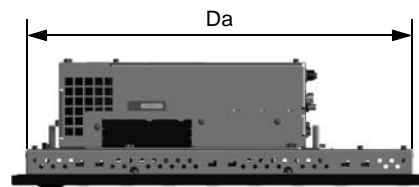
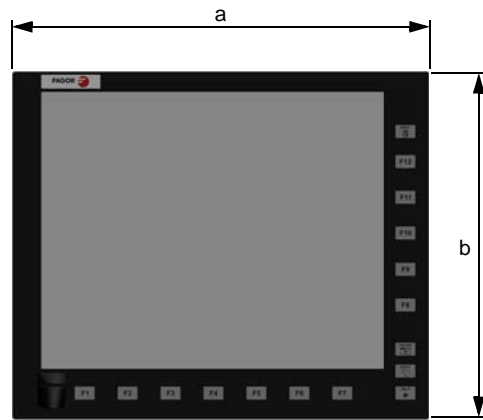
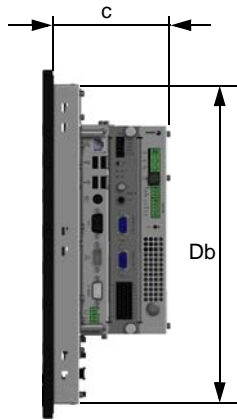

	mm	inch
a	420	16.54
b	350	13.78
c	124	4.88

	mm	inch
Da	389	15.31
Db	319	12.56



FAGOR AUTOMATION

CNC 8070

(REF: 1709)

4.4.5 C70-15A / C70-15AT.

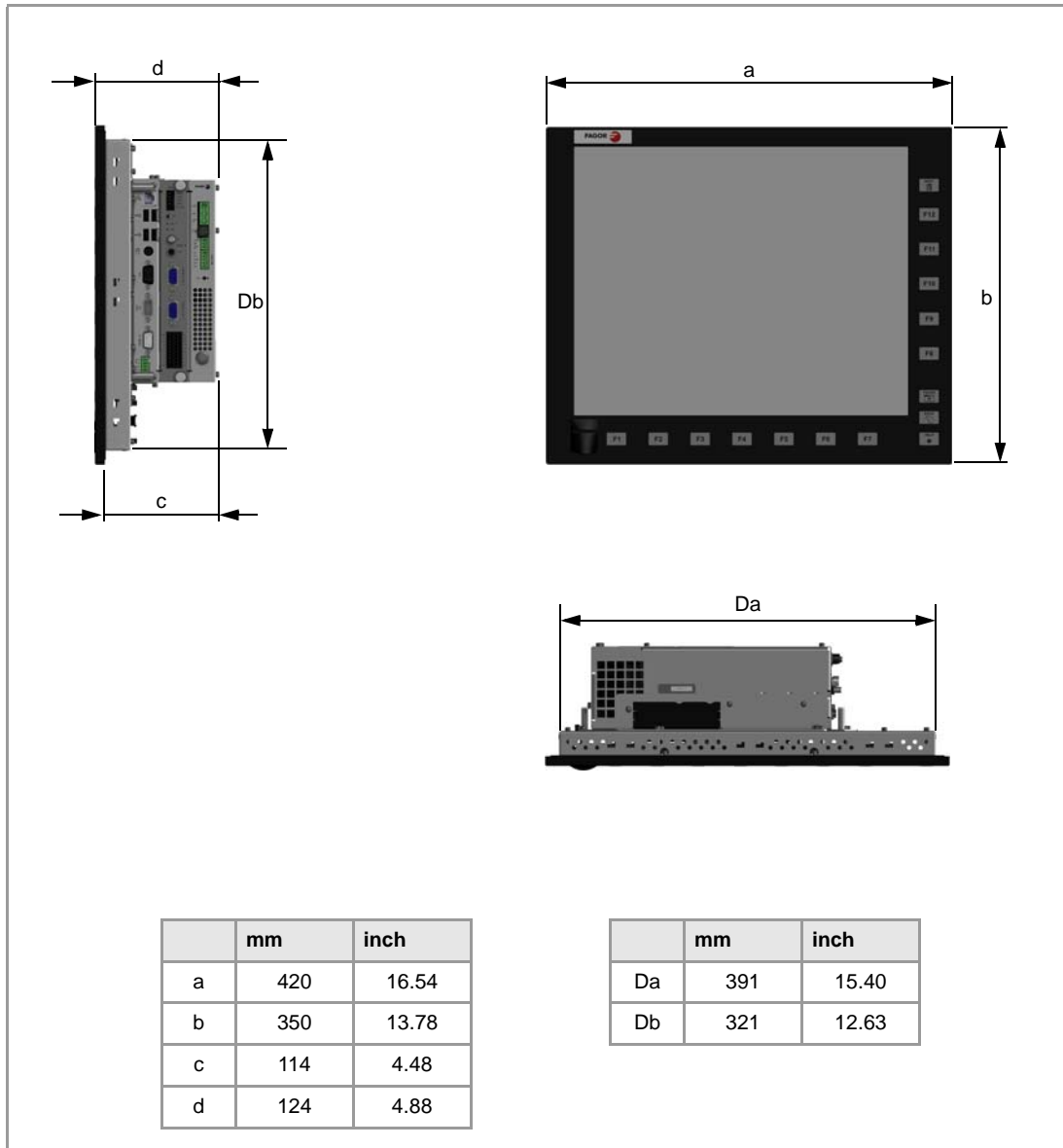

4.

C70-15 / C70-15T / C70-15A / C70-15AT C70-10K U70♦.



FAGOR AUTOMATION

CNC 8070

(REF: 1709)

4.5 Enclosure and securing of models C70-10 / C70-15.

4.5.1 Ambient characteristics of the enclosure.

The enclosure must ensure that the temperature inside does not exceed 55 °C (131 °F) while the device is in operating mode, with an ambient temperature of 45 °C (113 °F).

4.5.2 Enclosure design.

The enclosure must meet the following requirements:

- The enclosure must have enough surface area to evacuate by convection the heat generated inside.
- The enclosure must respect the minimum distances recommended between the enclosure walls and the central unit to let the air flow and improve heat dissipation.
- In the connector area, reserve a space that allows the cables to be connected, respecting their radius of curvature. Special care must be taken with the Sercos connection because bending the optic fiber too much could break it
- Keep the enclosure clean.

To meet the previous requirements, Fagor recommends the following.

- The enclosure must have an air input next to the cables and an air output next to the fan. In this case, install fans to ventilate the enclosure and keep the temperature within the allowed limits. Bear in mind that this air flow through the unit extracts hot air to the outside, but it allows dirt into the enclosure. Fagor recommends installing anti-dust filters at the air inputs and outputs.



Before building an enclosure with glass fiber or another poor heat dissipating material, contact Fagor Automation.

Dimensions of the cut off part and the enclosure.

C70-10K.

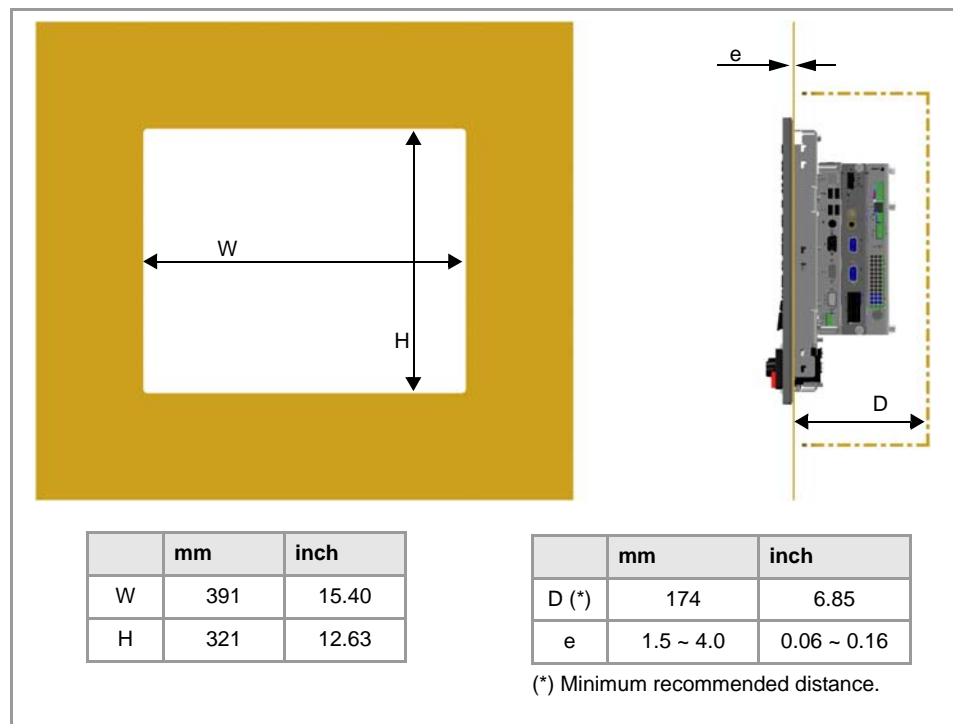

C70-15 / C70-15T / C70-15A / C70-15AT C70-10K U70



FAGOR AUTOMATION

CNC 8070

(REF: 1709)

C70-15 / C70-15T.

	mm	inch
W	392	15.43
H	322	12.67

	mm	inch
D (*)	174	6.85
e	1.5 ~ 4.0	0.06 ~ 0.16

(*) Minimum recommended distance.

C70-15A / C70-15AT.

	mm	inch
W	393	15.47
H	323	12.71

	mm	inch
D (*)	174	6.85
e	1.5 ~ 4.0	0.06 ~ 0.16

(*) Minimum recommended distance.

Even though the size of the cut-out for the models C70-15A and C70-15AT is mechanically compatible with models C70-15 and C70-15T, its size has been increased to facilitate assembly.

4.

C70-15 / C70-15T / C70-15A / C70-15AT C70-10K U70♦.



FAGOR AUTOMATION

CNC 8070

(REF: 1709)

4.5.3 Securing the module.

The module must be installed in a proper enclosure that may be located on the machine or on an external support. To insert the unit into the enclosure, it must have a big enough hole to allow to insert it easily, without obstacles and without forcing the unit.

The module is secured from the inside of the enclosure; therefore, there is no need to drill any holes on the front. Once the unit has been inserted into the enclosure, secure it from the inside with the tension jacks. To properly secure it, use all the tension jacks on the back of the unit. Apply a tightening torque of 0.7 Nm.

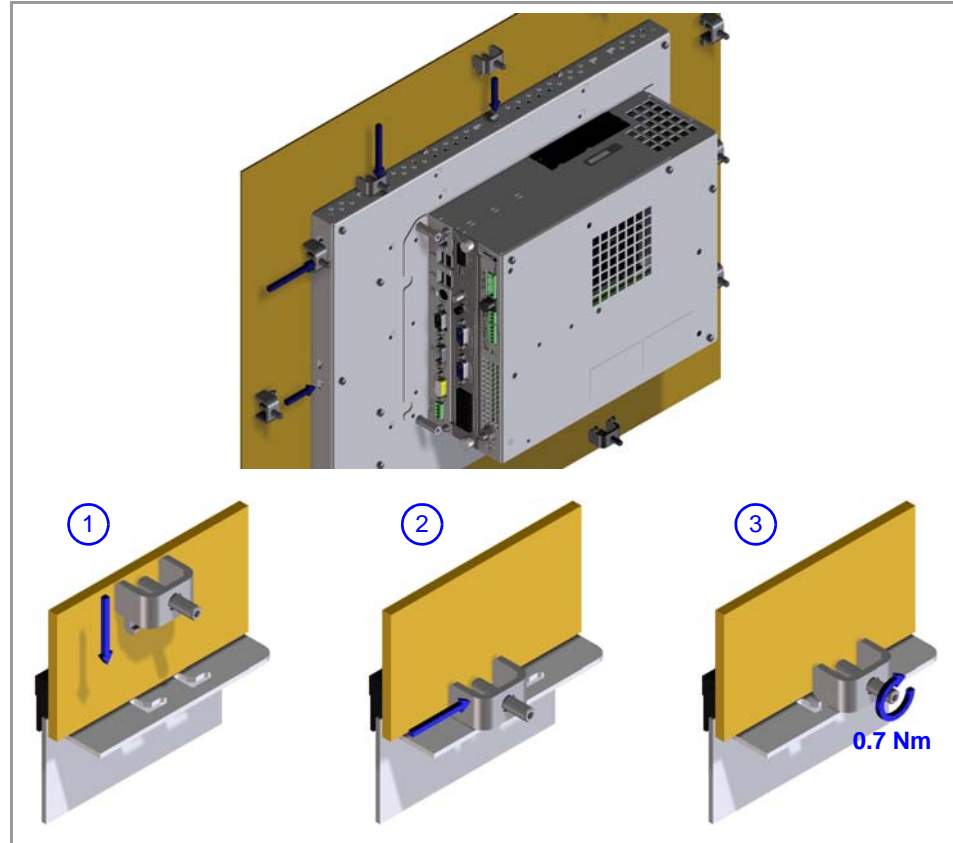

4.

C70-15 / C70-15T / C70-15A / C70-15AT / C70-10K U70♦.

4.6 Securing the U70 module.

4.6.1 Ambient characteristics of the cabinet.

The U70 module must be installed inside an electrical cabinet with a protection rating of IP54 or higher. The ventilation for the electrical cabinet must be enough to dissipate the heat generated by all the devices and components working inside. The interior temperature of the cabinet must not exceed 55°C (113°F) while the unit is running.

Dissipated power.

The modules generate heat and when trying to decide whether the electrical cabinet needs external cooling or not, one must know the power dissipated by each one of its modules.

CNC.	Dissipated power.
U70	85 watts.

4.6.2 Cabinet design.

When attaching the module, the following requirements must be met.

- Place the modules in a vertical position.
- To secure the module, use the holes and slots made for that purpose. Vibrations should be avoided. If necessary use securing means made of a material which absorbs or minimizes vibrations.
- Respect the minimum distances recommended between the enclosure walls and the central unit to let the air flow and improve heat dissipation.

4.6.3 Ventilation.

When installing the unit in the electrical cabinet, make sure to leave a clearance of at least 50 mm (1.97 inches) between it and the top, bottom and front panel of the cabinet or any other obstacle that obstructs air flow for better heat dissipation.

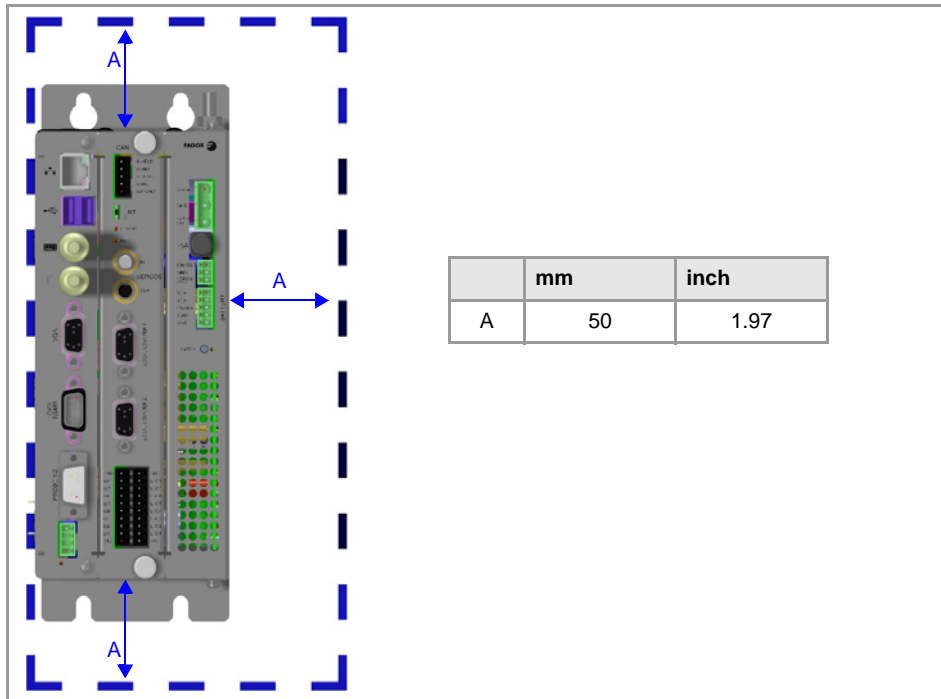

4.7 Power supply for the module.

4.

C70-15 / C70-15T / C70-15A / C70-15AT C70-10K U70♦.

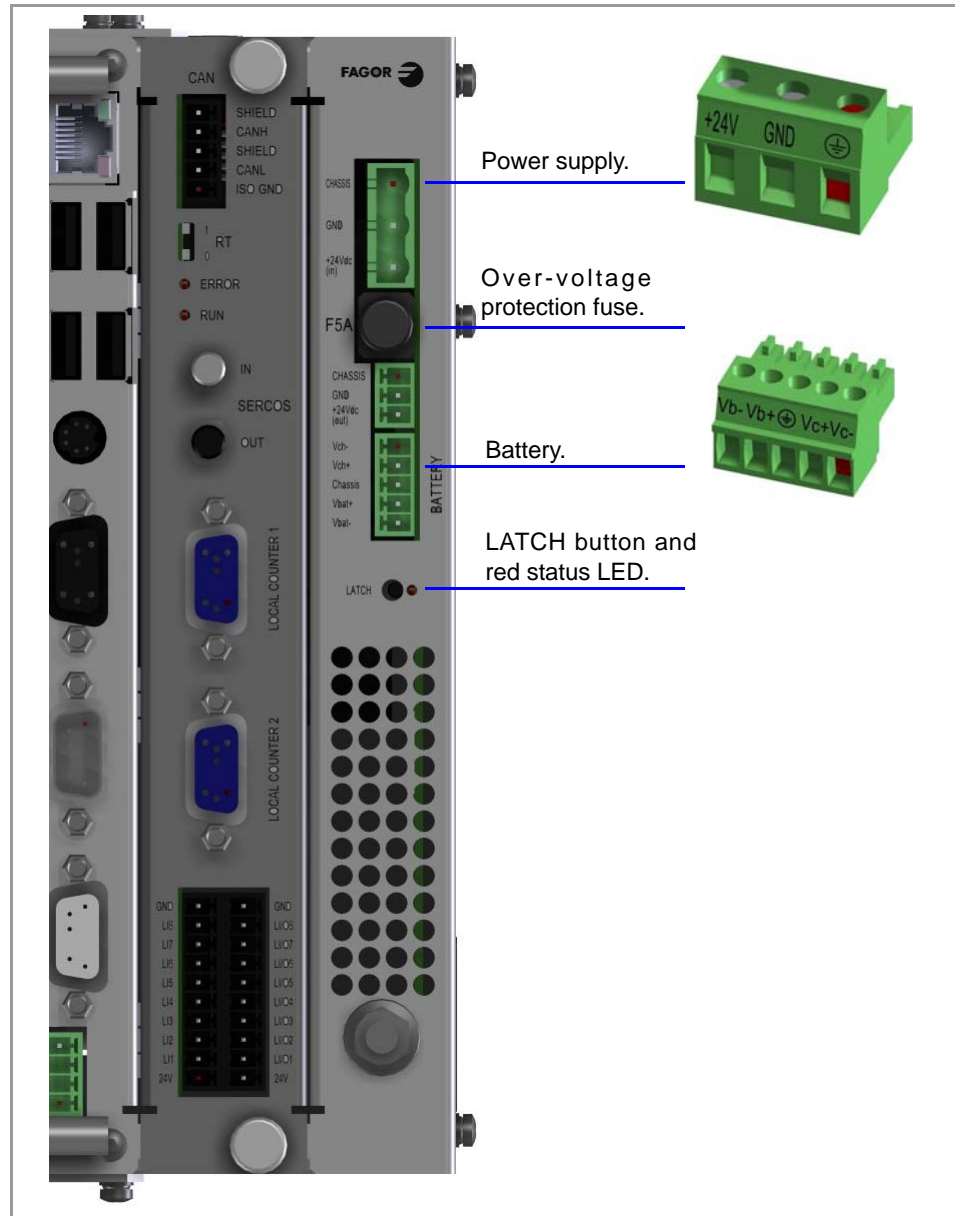

4.7.1 Voltage supply at 24 V DC.

Power the CNC with a 24 V DC $\pm 10\%$ 3.5 A power supply.

Current peak of 90 A on power-up.

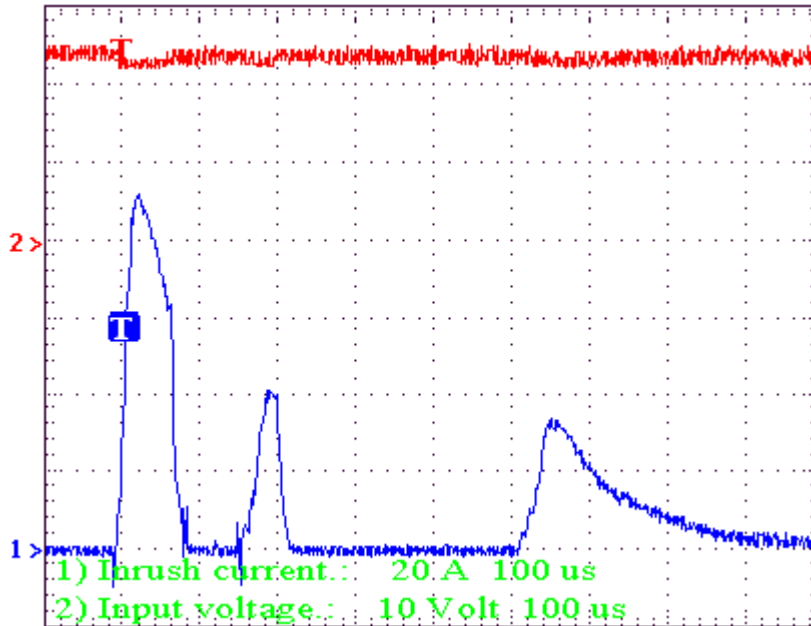

Connector pinout.

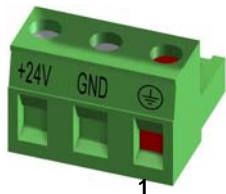

Plug-in part 3-pole Phoenix-type combicon connector (7.62 mm pitch). Rated current; 12 A.

Pin	Signal.	Function.
1		Chassis.
2	11	0 V reference signal.
3	+24 V	Power supply.

Consumption.

Consumption: 85 W (maximum).

4.7.2 Power supply with a Fagor battery.

Optionally, it is possible to connect an external Fagor battery to turn off the equipment in a controlled manner during a power outage. The battery provides an autonomy of about 20 minutes when it is fully charged.

Connector pinout.

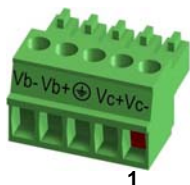

Plug-in part 5-pole Phoenix-contact minicombicon connector (3.5 mm pitch). Rated current; 8 A.

Pin	Signal.	Function.
1	Vc-	Recharging the battery through the central unit.
2	Vc+	
3		Chassis.
4	Vb+	Central unit powered by the battery.
5	Vb-	

4.

C70-15 / C70-15T / C70-15A / C70-15AT / C70-10K U70♦.

FAGOR

FAGOR AUTOMATION

CNC 8070

(REF: 1709)

4.7.3 Battery-powered RAM memory (non-volatile RAM).



Saving data in the battery-powered RAM required version V3.14 or higher.

The CNC has battery-powered RAM memory that keeps the information saved in it even when a power failure occurs. The RAM memory is powered by a battery that may be accessed from the outside. See "[4.10 housing for the compact flash and battery-powered RAM memory.](#)" on page 67.

The RAM memory with battery always saves the position of the axes, the rest of the data that it saves is determined by machine parameters, like for example, PLC registers (parameter BKUPREG), common arithmetic parameters (parameter BKUPCUP), etc.

4.7.4 Central unit protections.

Protection against over-voltage and reverse voltage.

The central unit has a fuse that may be accessed from the outside to protect against over-voltage (greater than 36 V DC or 25 V AC). The central unit is also protected against reverse connection of the power supply, preventing it from starting up.

Protection against over-current.

An over-current activates the safety device inside the power supply turns on the external red LED. The power supply will not be operative while the LED is on. There are two ways to reactivate the power supply after an over-current.

- Unplug the power supply from mains and wait for about 30 seconds until the red light turns off.
- Unplug the power supply and press the **·LATCH·** button. The red LED will turn off indicating that the power supply is ready.

If after reactivating the power supply, the LED turns back on, call the Technical Service Department.

Power outages.

Meets EN 61000-4-11 standard. The central unit is capable of withstanding micro-outages of up to 10 milliseconds.

C70-15 / C70-15T / C70-15A / C70-15AT / C70-10K / C70-10K U70♦.

4.



FAGOR AUTOMATION

CNC 8070

(REF: 1709)

4.8 Hardware functionality. Connectors.

4.8.1 Front of the monitor. USB connector.

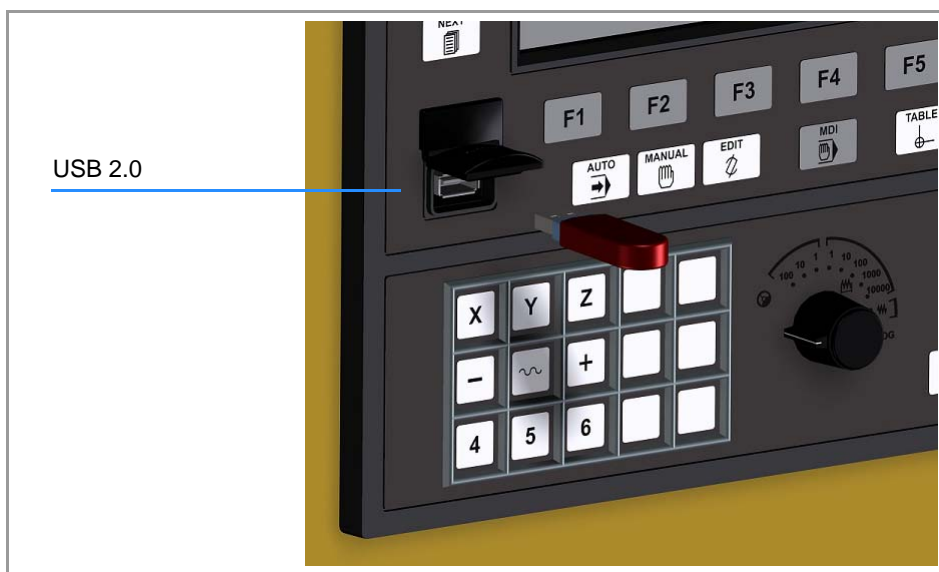

USB 2.0 port accessible from the front and protected by a cover, for the connection of a pendrive, mouse or keyboard. The cover must be tightly closed for the keyboard to comply with standard IP65.

4.

C70-15 / C70-15T / C70-15A / C70-15AT / C70-10K U70♦.

FAGOR 

FAGOR AUTOMATION

CNC 8070

(REF: 1709)

4.8.2 Central unit. Peripheral board.

4.

C70-15 / C70-15T / C70-15A / C70-15AT C70-10K U70♦.

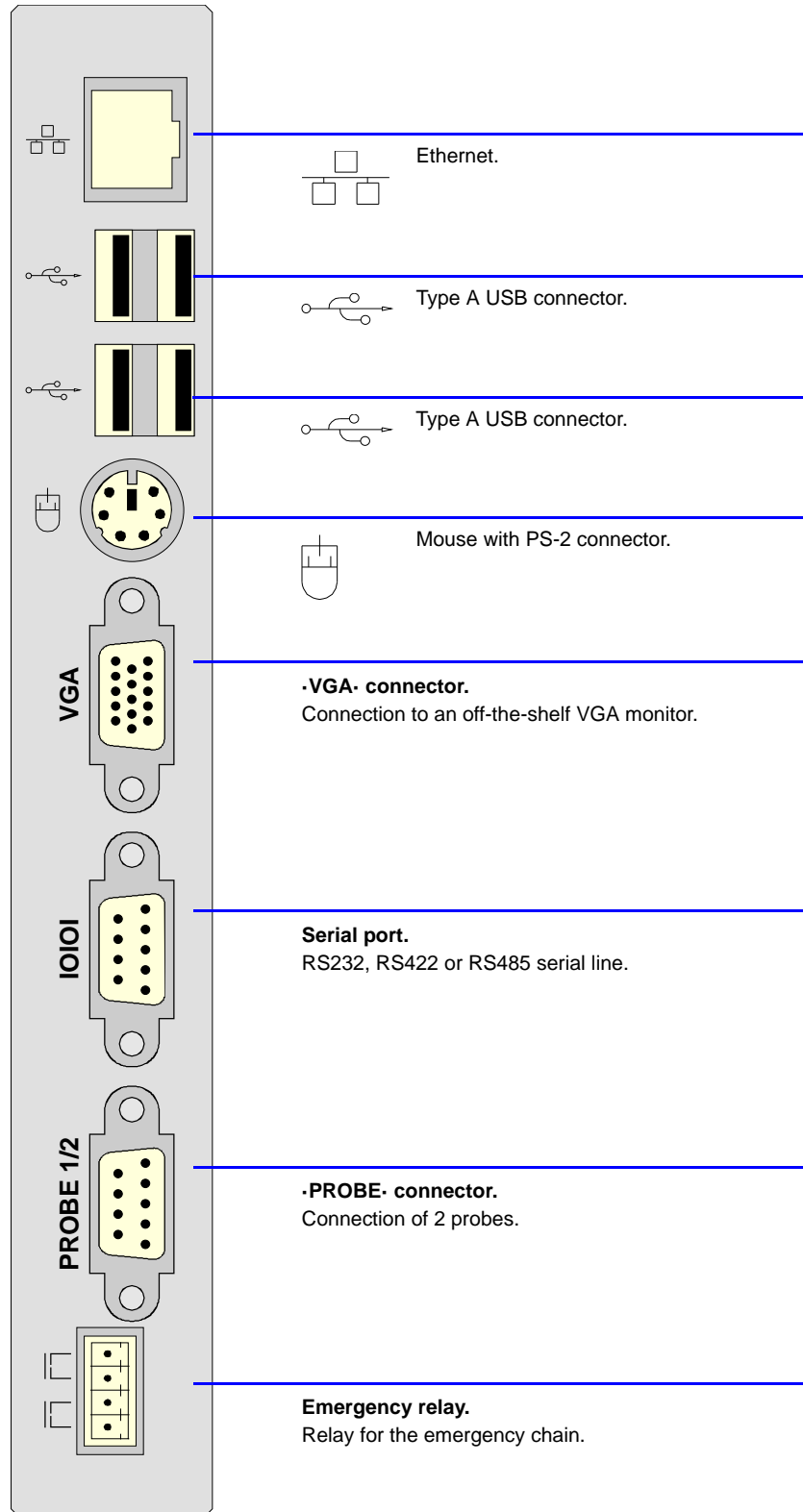

Ethernet.

8-pin RJ45 connector and 2 status LED's.

1 2 3 4 5 6 7 8

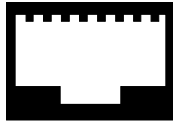

Pin.	Signal.
1	TX+ (transmit data).
2	TX- (transmit data).
3	RX+ (receive data).
4	---
5	---
6	RX- (receive data).
7	---
8	---

LED.	Meaning.
Green	The LED turns on when the central unit is connected to network.
Yellow	The LED blinks when data is being transferred.

4.

C70-15 / C70-15T / C70-15A / C70-15AT / C70-10K U70♦.

USB ports.

Type A USB double connector.

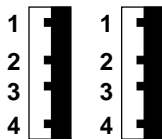

Pin.	Signal.
1	+ 5 V
2	DT -
3	DT +
4	11



No USB devices must be used nor connected while executing a part program. Using USB devices may slow down the execution or cause some "RT-IT overflow" type error.



USB devices must comply with the generic regulation IEC 61000-6-2:2005 on immunity for industrial use. We recommend to also comply with the European Directive 2004/108/EC on EMC for industrial use.

Mouse with PS-2 connector.

6-pin minidin female connector.

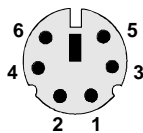

Pin.	Signal.
1	Mouse data.
2	---
3	11
4	+5 V
5	Mouse clock.
6	---

-VGA- connector.

15-pin female SUB-D HD type connector.

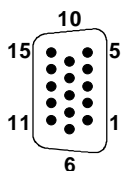

Pin.	Signal.
1	MAINS
2	GREEN
3	BLUE
4	---
5	11
6	GND_RED
7	GND_GREEN
8	GND_BLUE

Pin.	Signal.
9	---
10	GND_SYNC
11	---
12	---
13	HSYNC
14	VSUNC
15	---



FAGOR AUTOMATION

CNC 8070

(REF: 1709)

·IOIOI· connector. Serial line.

9-pin male SUB-D type connector.

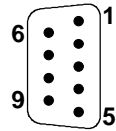

Pin.	RS232 signal.	RS422 signal.	RS485 signal.
1	DCD	---	---
2	RxD	LineTerm 120 Ω.	LineTerm 120 Ω.
3	TxD	/LineTerm 120 Ω.	/LineTerm 120 Ω.
4	DTR	---	---
5	11	11	11
6	DSR	TxD	TxD RxD
7	RTS	/TxD	/TxD /RxD
8	CTS	RxD	TxD RxD
9	RI	/RxD	/TxD /RxD

At the CNC, the type of serial line is selected by means of the machine parameters (parameter RSTYPE).

·PROBE· connector. Probe connection.

9-pin female SUB-D type connector.

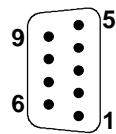

Pin.	Signal.	Description.
1	Chassis	Shield.
2	PRB1 +5 V	5 V output for probe 1.
3	PRB1 IN5V	5 V input of probe 1.
4	PRB1 IN24V	24 V input of probe 1.
5	PRB1 GND	0 V reference input of probe 1.
6	PRB2 +5 V	5 V output for probe 2.
7	PRB2 IN5V	5 V input of probe 2.
8	PRB2 IN24V	24 V input of probe 2.
9	PRB2 GND	0 V reference input of probe 2.

Relay for the emergency chain.

4-pin male Phoenix-contact minicomblon connector (3.5 mm pitch).

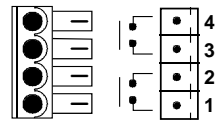

The relay contacts are normally open and they close when the CNC is powered up and running properly; they open again when the CNC is turned off or when an internal failure occurs.

These relays withstand up to 1A at 24V.

C70-15 / C70-15T / C70-15A / C70-15AT / C70-10K U70

4.



FAGOR AUTOMATION

CNC 8070

(REF: 1709)

4.8.3 Central unit. Expansion board.

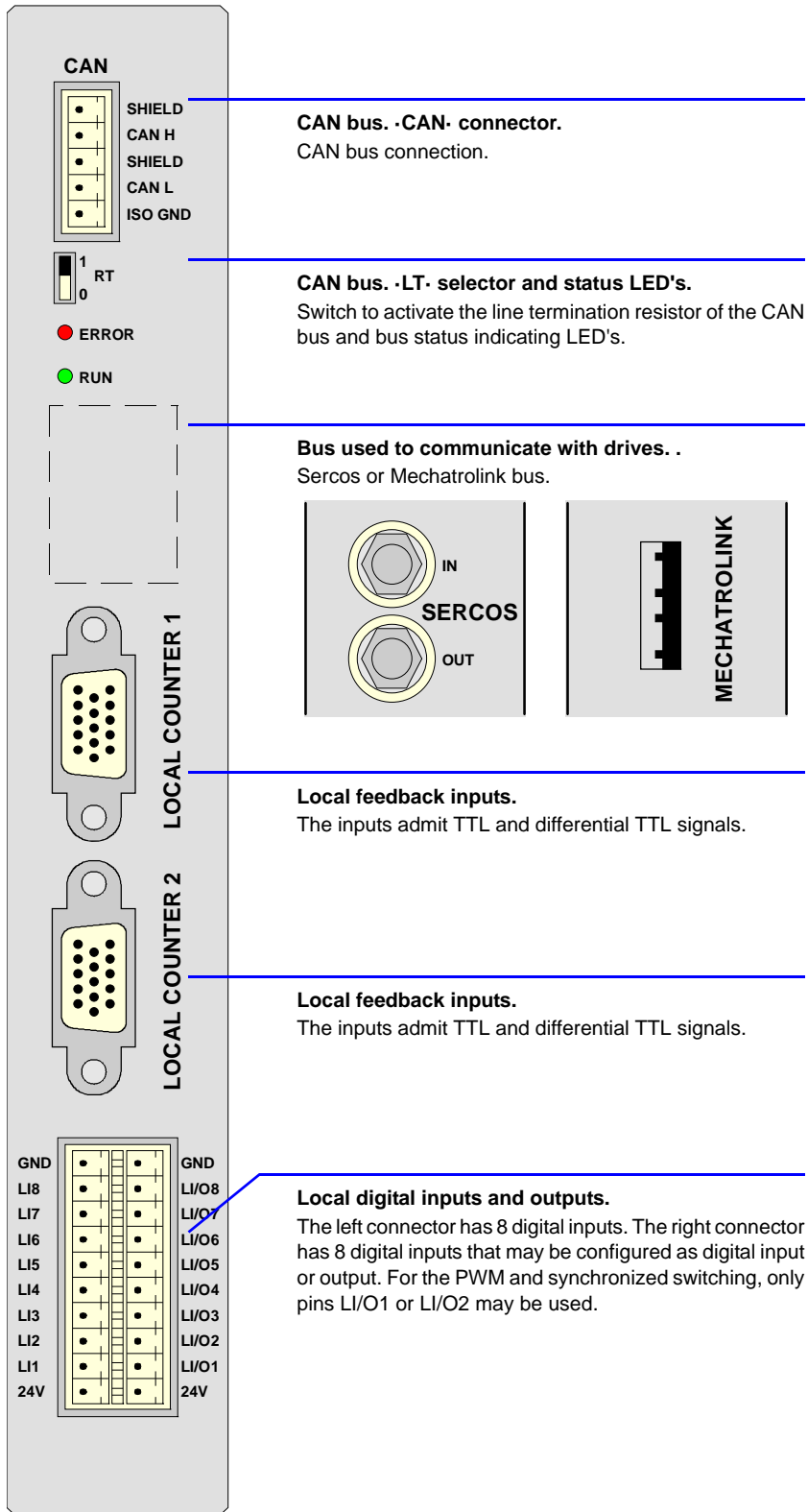

4.

C70-15 / C70-15T / C70-15A / C70-15AT / C70-10K U70♦.



CNC 8070

(REF: 1709)

CAN bus. ·CAN· connector.

5-pin male Phoenix-contact minicombicon connector (3.5 mm pitch).

SHIELD		5		Pin.	Signal.	Function.
CAN H		4		1	ISO GND	Ground / 0 V.
SHIELD		3		2	CAN L	(LOW) bus signal.
CAN L		2		3	SHIELD	CAN shield.
ISO GND		1		4	CAN H	(HIGH) bus signal.
				5	SHIELD	CAN shield.

CAN bus. ·LT· selector.

Line terminating resistor. The ·LT· switch identifies which are the elements that occupy the ends of the CAN bus; i.e. the first and last physical element in the connection.

The switch position of the terminating elements must be "1" and that of the rest of the elements "0".

CAN bus. ·ERROR· LED.

Red LED. Its meaning depends on the blinking frequency.

Type of blinking.	Meaning.
LED off.	The module works properly.
Blinking fast.	Module configuration stage.
Single blinking.	Warning. Poor transmission.
Double blinking.	There is no communication with the cpu.
LED on.	Error. Too many errors.

CAN bus. ·RUN· LED.

Green LED. Its meaning depends on the blinking frequency.

Type of blinking.	Meaning.
LED on.	The module works properly.
Single blinking.	Module stopped.
Blinking fast.	Module configuration stage.
Continuous blinking.	Start-up stage or error.

Bus used to communicate with drives. Sercos II bus.

·IN· & ·OUT· connectors Honeywell emitter and receiver.

	Signal.	Function.
IN	IN	Sercos signal receiver.
	OUT	Sercos signal emitter.
OUT		

C70-15 / C70-15T / C70-15A / C70-15AT C70-10K U70♦.

Bus used to communicate with drives. Mechatrolink bus.

A type USB connector with retainers.

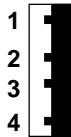

Pin.	Signal.
1	---
2	DT -
3	DT +
4	---

Local feedback inputs (TTL, differential TTL).

2 15-pin female SUB-D HD type connectors.

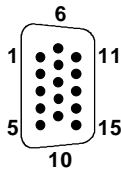

Pin.	Signal.	Description.
1	A	Feedback signals.
2	/A	
3	B	
4	/B	
5	I0	Reference signals.
6	/I0	
7	AL	Feedback alarm.
8	/AL	
9	+5 V DC	Voltage supply for the feedback system.
10	---	
11	11	0 V reference signal.
12	---	
13	---	
14	---	
15	Chassis(*)	Shield.

(*) Pin -15- is offered for compatibility. We recommend to connect the cable shield to the connector housing at both ends.

See "4.9.4 Feedback inputs." on page 66. See "4.12.5 Feedback connection." on page 76.

Local digital inputs (8 inputs). Local digital inputs or outputs (as configured).

10x2-pin two-level male Phoenix.contact minicombicon connector (3.5 mm pitch).

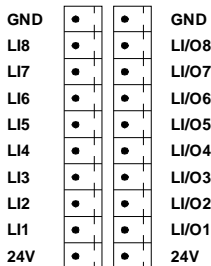

Signal	Function
11	0 V reference signal.
LI1 - LI8	Digital inputs.
LI/O1 - LI/O8	Digital input or output (as configured).
24 V	24 V DC voltage supply.

Each LI/O pin of this connector may be configured as digital input or output by machine parameters. When a digital output is active, the connector must be connected to 24 V DC and GND.

Machine parameter NLOCOUT indicates the number of digital outputs available at the connector, the rest of the pins will act as digital inputs. Refer to the installation manual for further detail.

4.8.4 Central unit. CPU board.

4.

C70-15 / C70-15T / C70-15A / C70-15AT C70-10K U70♦.

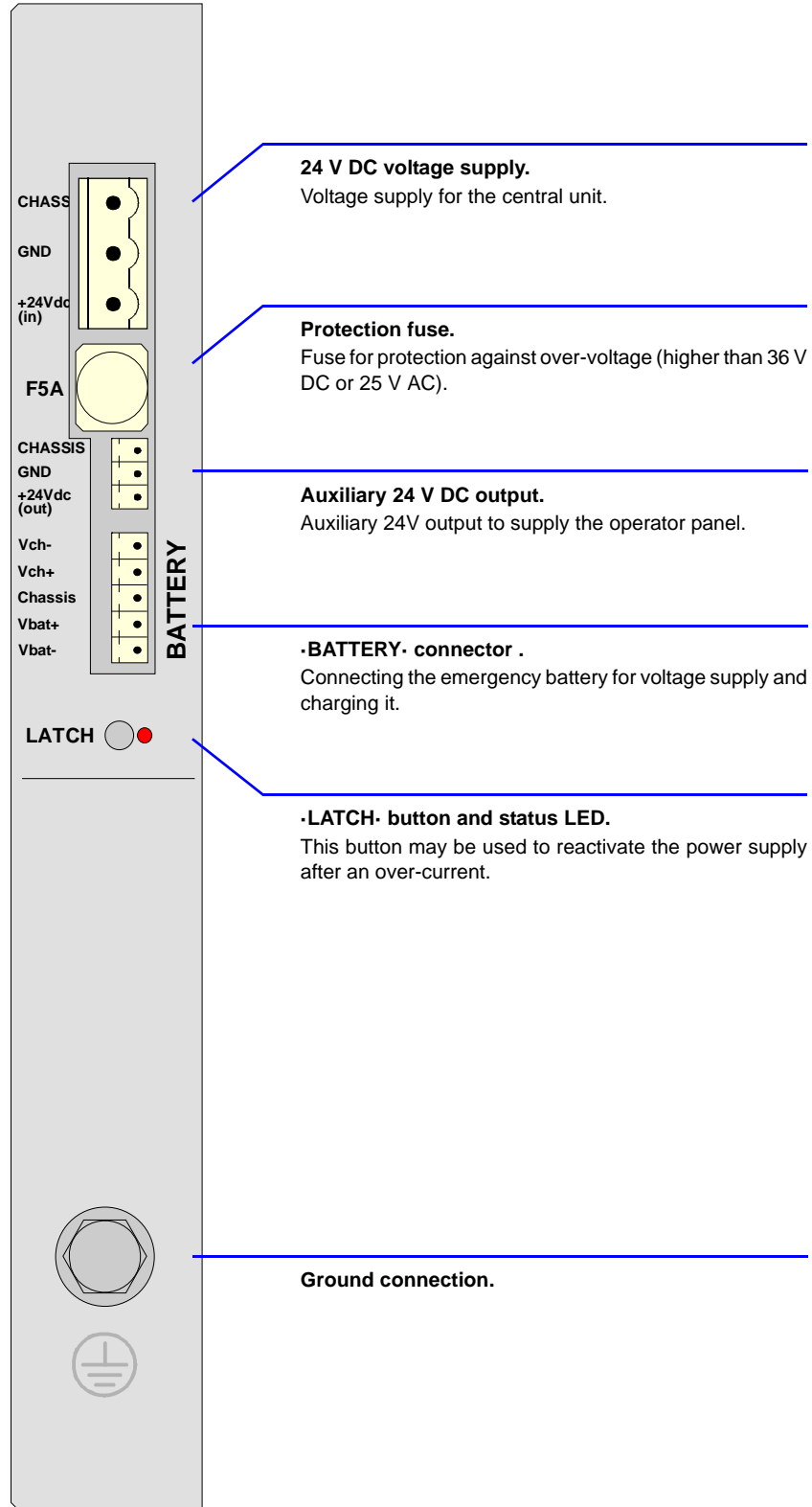

Power supply.

3-pin male Phoenix-contact combicom connector (7.62 mm pitch).

	1	Chassis	Signal.	Function.
	2	GND	Chassis	Shield.
	3	+24 V	11	Power supply.
			+24 V	Power supply.

Connector to power the central unit with universal 24 V DC. See "4.7 Power supply for the module." on page 50.

Protection fuse.

The module has a 5 A fuse that may be accessed from the outside to protect against over-voltage (greater than 36 V DC or 25 V AC).

Auxiliary 24V output to supply the operator panel.

3-pin male Phoenix-contact minicombicon connector (3.5 mm pitch).

	1	Chassis	Signal.	Function.
	2	GND	Chassis	Shield.
	3	+24 V	11	Power supply.
			+24 V	Power supply.

This connector offers the possibility to supply voltage from the central unit to the operator panel. It is mainly oriented to those configurations where the operator panel is integrated into the monitor (LCD-10K) or close to it.

-BATTERY- connector . Battery voltage and charge.

5-pin male Phoenix-contact minicombicon connector (3.5 mm pitch).

	1	Vch -	Signal	Function
	2	Vch +	Vbat -	Central unit powered by the battery.
	3	Chassis	Vbat +	
	4	Vbat +	Chassis	Shield.
	5	Vbat -	Vch -	Recharging the battery through the central unit.
			Vch +	

This connector can also be used to connect an external battery that ensures the proper shut-down of the unit due to a power failure. The battery provides an autonomy of about 20 minutes when it is fully charged.

-LATCH- button and status LED's.

When the red LED is on, it means that there is an over-current at the power supply and it is not running. The -LATCH- button may be used to reactivate the power supply after an over-current.

4.

C70-15 / C70-15T / C70-15A / C70-15AT / C70-10K U70 ♦.



FAGOR AUTOMATION

CNC 8070

(REF: 1709)

4.8.5 PCI expansion board (only for the MCU model).

4.

C70-15 / C70-15T / C70-15A / C70-15AT / C70-10K U70♦.

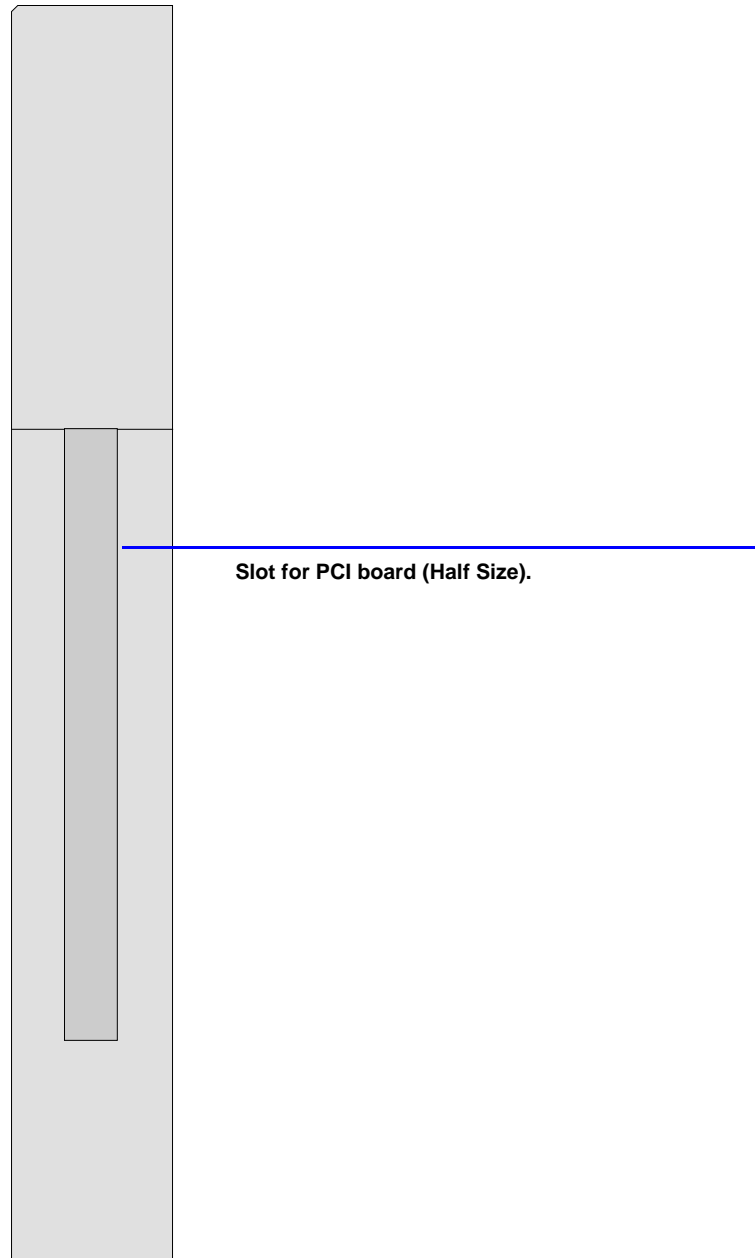



Electrical characteristics of the PCI expansion.

Characteristic.	Description.
Board size.	Half Size.
Connector.	PCI 5 V.
Interface.	PCI 32 bit 33 MHz
Power supply.	5 V / 2 A - 3.3 V / 2.5 A (Both may be used with a maximum consumption of 15W).
V(I/O)	May be set for 5V or 3.3 V using a jumper (by default, 5 V).

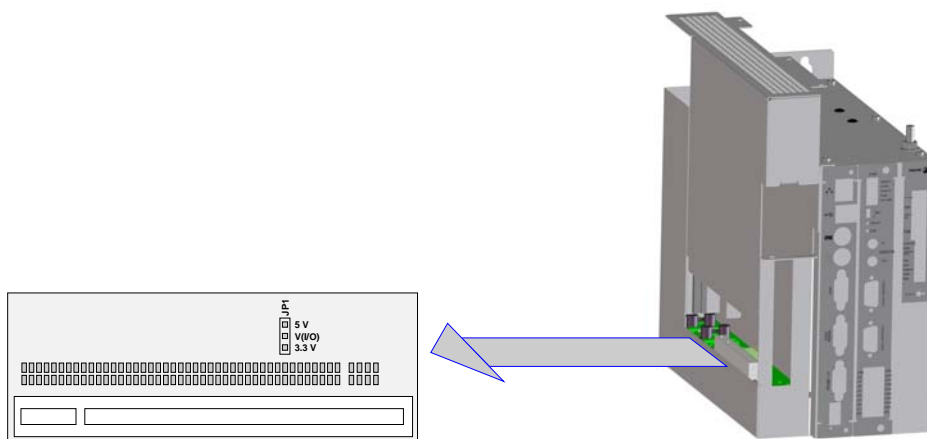
Jumper -JP1-. Voltage selector V(I/O).

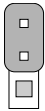

3-pin jumper for selecting the voltage of V(I/O).

-JP1-	Selected voltage.
 <p>5 V V(I/O) 3.3 V</p>	5 V
 <p>5 V V(I/O) 3.3 V</p>	3.3 V

4.

C70-15 / C70-15T / C70-15A / C70-15AT / C70-10K U70♦.

4.8.6 Handwheel connector (only for C70-10K).

4.

C70-15 / C70-15T / C70-15A / C70-15AT C70-10K U70♦.

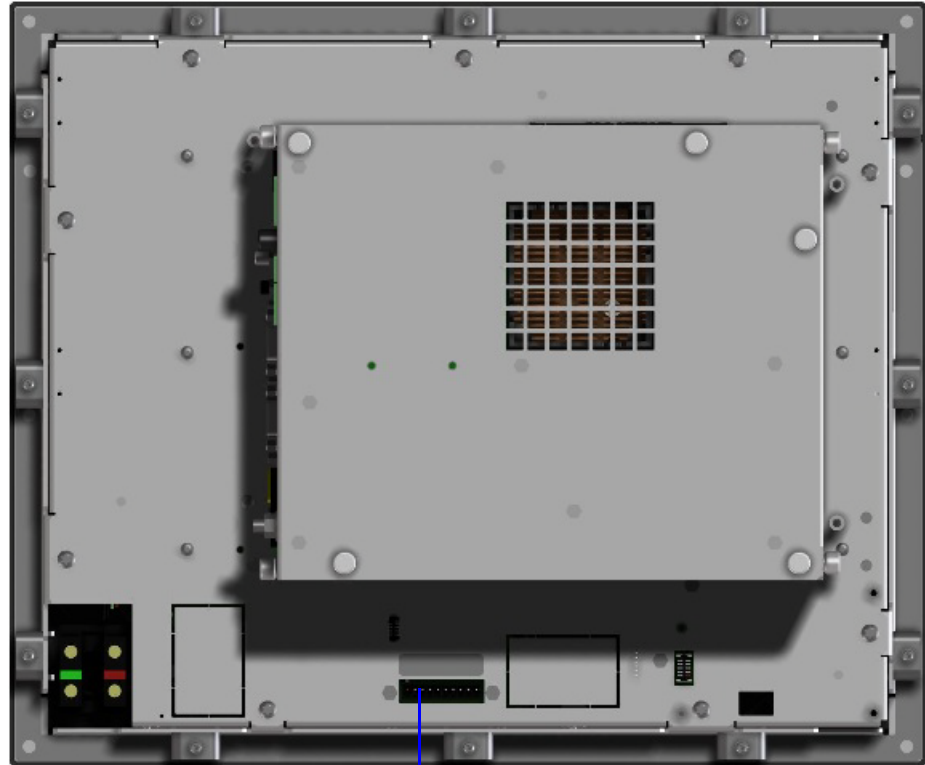

Rear view.

X11 Handwheel.
Handwheel connection.

Connector X11. Handwheel connection.

10-pin male Phoenix minicombicon contact (3.5 mm pitch).

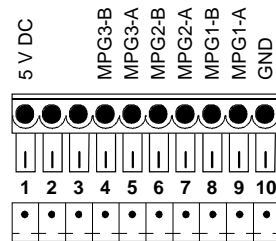

Pin	Signal	Function
1	+5 V	Power supply.
2	---	
3	---	
4	MPG3-B	B signal of the third handwheel.
5	MPG3-A	A signal of the third handwheel.
6	MPG2-B	B signal of the second handwheel.
7	MPG2-A	A signal of the second handwheel.
8	MPG1-B	B signal of the first handwheel.
9	MPG1-A	A signal of the first handwheel.
10	11	Power supply.



Cable shields must be connected to the ground plate. See "4.12.5 Feedback connection." on page 76.

The C70-10K model admits the connection of up to 3 handwheels (MPG1, MPG2 and MPG3) with A and B signals (5 V DC TTL). If the handwheel has an axis selector button, the button signal may be connected to a digital input and may be managed from the PLC using the NEXTMPGAXIS mark.

4.9 Technical/electrical characteristics of the inputs and outputs.

4.9.1 Digital inputs.

All digital inputs are galvanically isolated through opto-couplers. All the digital inputs have the following characteristics:

Characteristic.	Value.
Nominal voltage.	+24 V DC (between +18 V DC and +30 V DC).
High threshold "1".	Over +18 V DC.
Low threshold "0".	Under +9 V DC.
Typical consumption of each input.	5 mA.
Maximum consumption of each input.	7 mA.

4.9.2 Digital outputs.

All digital outputs are galvanically isolated through opto-couplers. All the digital outputs have the following characteristics:

Characteristic.	Value.
Nominal voltage.	+24 V DC (between +18 V DC and +30 V DC).
Output voltage.	2 V less than the supply voltage.
Maximum output current.	500 mA per output.
Minimum cycle on.	Pins LI/O1 LI/O2: 25 μ s (optional). Rest of pins: 75 μ s.



For the PWM and synchronized switching, only pins LI/O1 or LI/O2 may be used. Depending on the input receiving the PWM pulse and the cable, an external load resistor (at least 10% of rated current; if 24 V, 470 Ω / 2 W) improves signal quality and noise immunity.

4.9.3 Analog outputs.

Use shielded cables connecting their meshes to the corresponding shield pin. All the analog outputs have the following characteristics:

Characteristic.	Value.
Command voltage within range.	± 10 V.
Resolution.	16 bits.
Minimum impedance of the connected device.	10 k Ω .
Maximum cable length (unshielded).	75 mm.

4.

C70-15 / C70-15T / C70-15A / C70-15AT / C70-10K U70♦.

FAGOR

FAGOR AUTOMATION

CNC 8070

(REF: 1709)

4.9.4 Feedback inputs.

The central unit has 2 feedback inputs, valid for TTL and differential TTL signals.

Characteristic.	Value.
+5 V power consumption.	250 mA for each input.

Work levels for TTL signal.

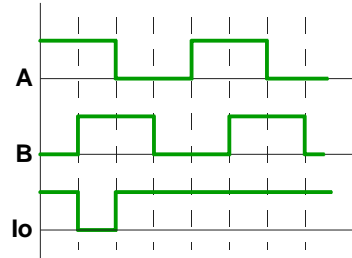

Characteristic.	Value.
Maximum frequency:	100 kHz.
Phase difference:	$90^\circ \pm 20^\circ$.
High threshold (logic level "1") VIH:	$2,2 \text{ V} < \text{VIH} < 5 \text{ V}$.
Low threshold (logic level "0") VIL:	$-1 \text{ V} < \text{VIL} < 0,6 \text{ V}$.
Maximum voltage:	$-1 \text{ V} \div 7 \text{ V}$
Hysteresis:	1.2 V.

Work levels for differential TTL signal.

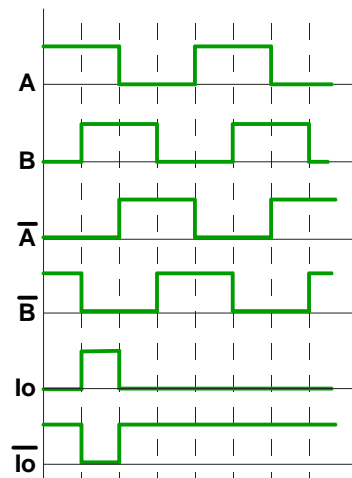

Characteristic.	Value.
Maximum frequency:	1000 kHz.
Phase difference:	$90^\circ \pm 20^\circ$.
Maximum voltage in common mode:	$-1 \text{ V} \div 7 \text{ V}$
Maximum voltage in differential mode:	$\pm 6 \text{ V}$.
Hysteresis:	0.2 V.
Maximum differential input current:	50 mA.

4.

C70-15 / C70-15T / C70-15A / C70-15AT / C70-10K U70♦.

4.10 housing for the compact flash and battery-powered RAM memory.

The housing for the compact flash and the battery of the non-volatile RAM memory is located on top of the central unit. The type of battery depends on the CNC model.

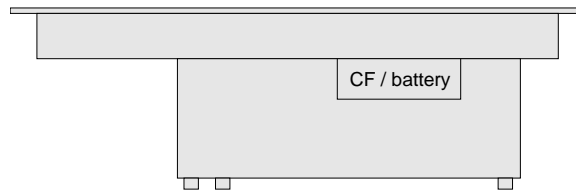

How to replace the battery of the non-volatile RAM memory (3Volt CR2450).

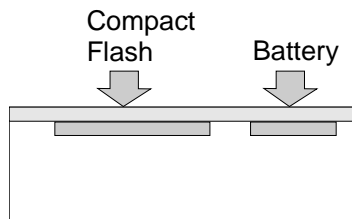

- 1 Turn the CNC off and unplug it.
- 2 Get into the enclosure by removing the protective cover.
- 3 Remove the battery by pulling it up smoothly.
- 4 Insert the new battery maintaining the same polarity. The battery must get into its housing easily, without having to force it.
- 5 Put the protective cover back on.
- 6 Plug the unit in.

While the battery is being replaced, the CNC keeps the data of the non-volatile RAM memory.

How to replace the battery of the non-volatile RAM memory (CN371).

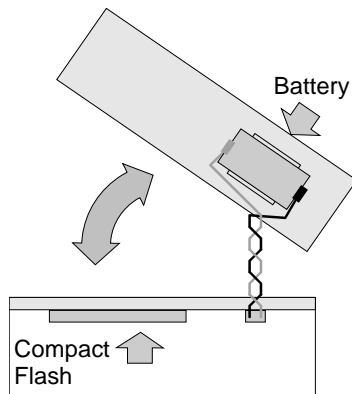

- 1 Turn the CNC off and unplug it.
- 2 Get into the enclosure by removing the protective cover.
- 3 Disconnect the battery from the CNC by pulling the connector softly. Remove the battery from the lid.
- 4 Secure the battery on the lid and connect the battery to the CNC respecting its polarity.
- 5 Put the protective cover back on.
- 6 Plug the unit in.

While the battery is being replaced, the CNC keeps the data of the non-volatile RAM memory.

4.

C70-15 / C70-15T / C70-15A / C70-15AT / C70-10K U70♦.

FAGOR 

FAGOR AUTOMATION

CNC 8070

(REF: 1709)

4.11 Insert the board into the PCI expansion (only in MCU models).

Precaution when handling the boards.

Handle the boards very carefully to avoid damaging them or their elements, contacts or conducting lines. Place the modules in the correct position. Do not use a sharp-pointed object (like a screwdriver) as a lever.



This symbol identifies the cards as ESD components (sensitive to electrostatic discharges). Bear in mind the following considerations when handling boards with ESD:

- Before handling the ESD boards, discharge their static electricity (for example by touching an object that is connected to ground).
- The units and tools being used must be free of any static charge-
- Turn the power supply of the unit off before inserting or removing the board.
- Hold the ESD board only at its corners or edges; do not touch its components, contacts or conducting lines.

Voltage for the pins V(I/O).

The supply voltage for the V(I/O) pins of the connector may be set for 5V or 3.3V (by default, 5 V). See "[4.8.5 PCI expansion board \(only for the MCU model\).](#)" on page 62.

Mounting the boards.



Do not open the unit or handle the internal boards while the unit is connected to power. Before opening the unit, make sure that the unit is unplugged from the power outlet.

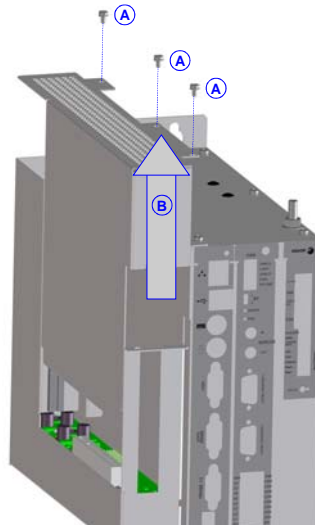

Remove the three mounting screws (A) of the lid, located on top and slide the lid in the direction of the arrow (B).

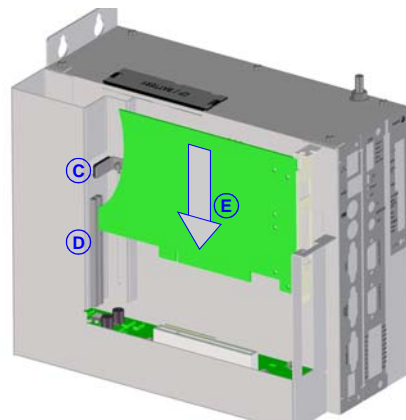

Loosen the locking angle bracket (C) and turn it to allow the board to slide in. Insert the board in the slot (D) and push it in the direction of the arrow (E) all the way in.

C70-15 / C70-15T / C70-15A / C70-15AT C70-10K U70

Hardware configuration.

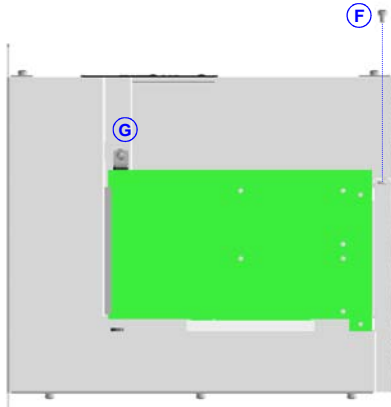

Secure the board with the screw (F). Turn and fasten the locking angle bracket (G) to hold the board.

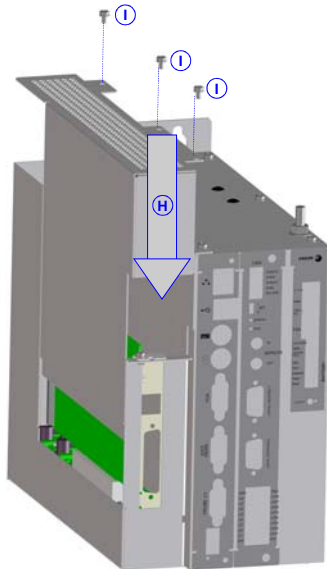

Put and slide the lid in the direction of the arrow (H). Fasten the three mounting screws (I) of the lid.

4.

C70-15 / C70-15T / C70-15A / C70-15AT / C70-10K U70♦.

FAGOR 
FAGOR AUTOMATION

CNC 8070

(REF: 1709)

4.12 Connections.

4.12.1 Probe connection.

Connector pinout.

Plug-in part 9-pin male SUB-D type connector.

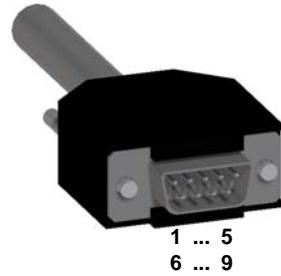

Pin.	Signal.	Description.
1	Chassis	Shield.
2	PRB1 +5 V	5 V output for probe 1.
3	PRB1 IN5V	5 V input of probe 1.
4	PRB1 IN24V	24 V input of probe 1.
5	PRB1 GND	0 V reference input of probe 1.
6	PRB2 +5 V	5 V output for probe 2.
7	PRB2 IN5V	5 V input of probe 2.
8	PRB2 IN24V	24 V input of probe 2.
9	PRB2 GND	0 V reference input of probe 2.

All the shields of the cables must be connected to ground only at the CNC through pin -1- of the connector, leaving the other one free. The wires of the shielded cable must not be longer than 75 mm without the protection shield.

Probe connection.

The CNC has two probe inputs, either 5 V to 24 V. In the following diagrams, the first probe input is used (pins -2- to -5-); to use the second input, use pins -6- to -9-.

Probe whose output has a normally open contact. Connection to +5 V.

The connection acts upon the up flank (positive pulse) of the probe signal.

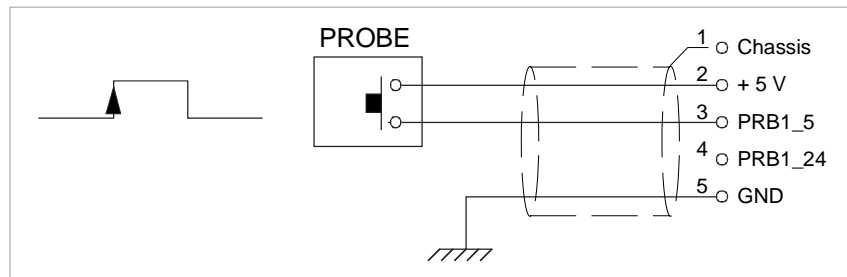

Probe whose output has a normally open contact. Connection to +24 V.

The connection acts upon the up flank (positive pulse) of the probe signal.

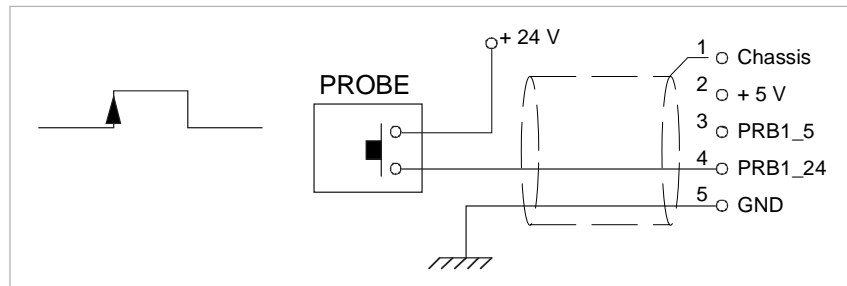

Hardware configuration.

Probe whose output has a normally closed contact. Connection to +5 V.

The connection acts upon the up flank (positive pulse) of the probe signal.

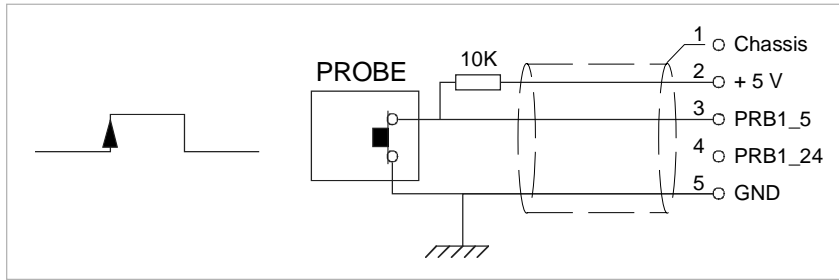

Probe whose output has a normally closed contact. Connection to +24 V.

The connection acts upon the up flank (positive pulse) of the probe signal.

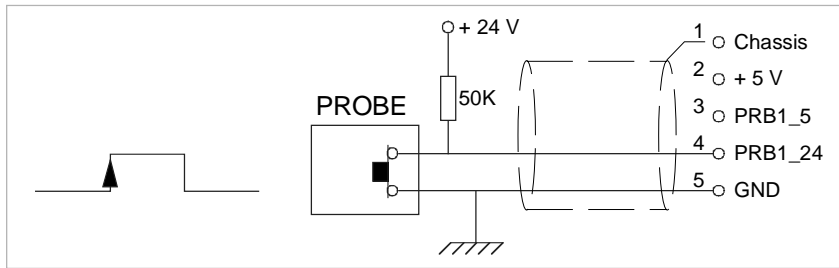

Interface with an open-collector output. Connection to +5 V.

The connection acts upon the down flank (negative pulse) of the probe signal.

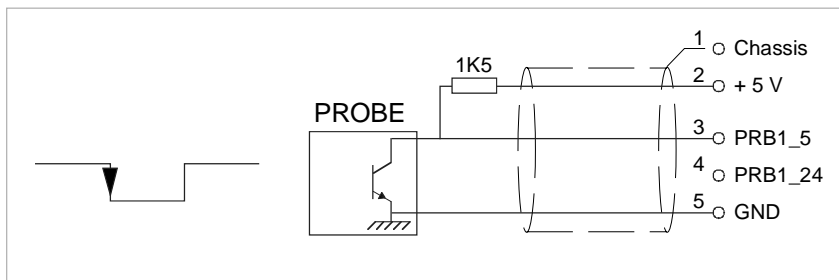

Interface with an open-collector output. Connection to +24 V.

The connection acts upon the down flank (negative pulse) of the probe signal.

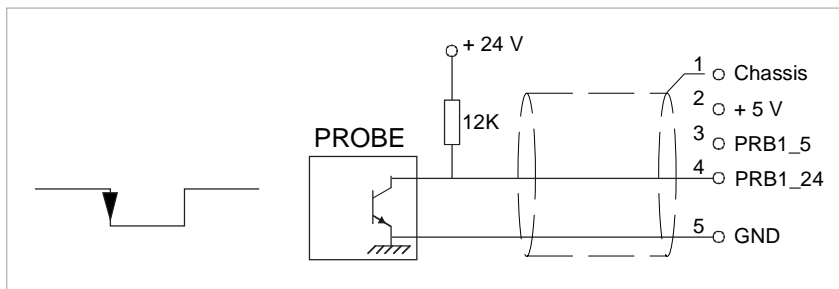

4.

C70-15 / C70-15T / C70-15A / C70-15AT C70-10K U70



FAGOR AUTOMATION

CNC 8070

(REF: 1709)

Interface with a PUSH-PULL output. Connection to +5 V.

Depending on the interface being used, the connection acts upon the up flank or down flank of the probe signal.

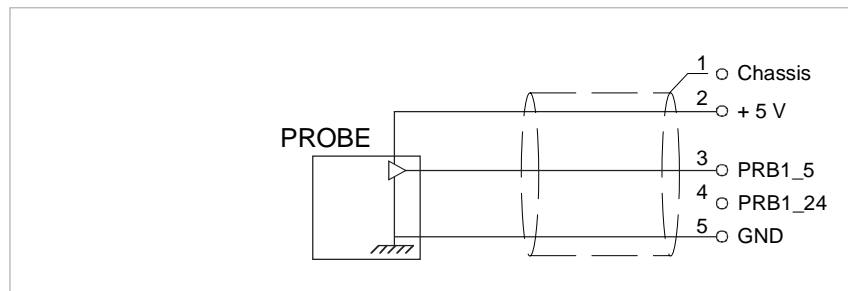

Interface with a PUSH-PULL output. Connection to +24 V.

Depending on the interface being used, the connection acts upon the up flank or down flank of the probe signal.

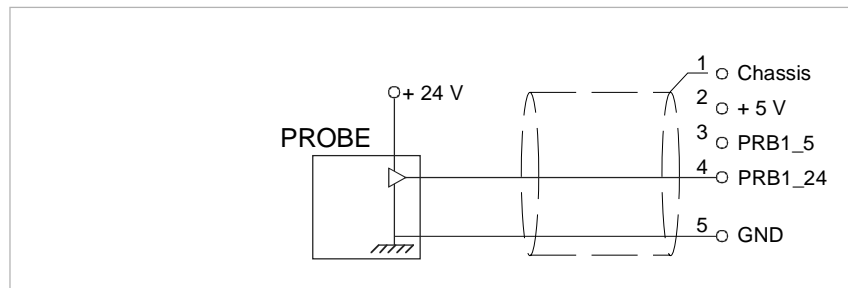

C70-15 / C70-15T / C70-15A / C70-15AT C70-10K U70♦.

4.

4.12.2 RS232 serial line connection.

Connector pinout.

Plug-in part 9-pin female SUB-D type connector.

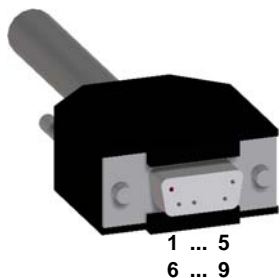

Pin.	Signal.	Description.
1	DCD	Carrier detect.
2	RxD	Receive data.
3	TxD	Send data.
4	DTR	Data terminal ready.
5	11	Reference signal.
6	DSR	Data set ready.
7	RTS	Request to send.
8	CTS	Clear to send.
9	RI	Ring indicator.

4.

C70-15 / C70-15T / C70-15A / C70-15AT C70-10K U70♦.

Cable characteristics.

Twisted-pair shielded cable should be used to minimize interference between cables, thus preventing poor communication in long lengths.

Characteristic.	
Type.	Shielded. Twisted-pair, with a minimum wire section of 0.14 mm ² .
Capacitance.	164 pF/m (50 pF/ft).
Maximum length.	At a baudrate of 19200 Bd, 15 m (50 ft) or a length equivalent to a capacitance of 2500 pF.

Node connection.

The cable shield must be connected to the connector at both ends. It is recommended to reference all the control and data signals to the same point (pin 5 GND), thus avoiding reference points with different voltages because there could be voltage differences in long lengths between the two ends of the cable.

- Simplified connection

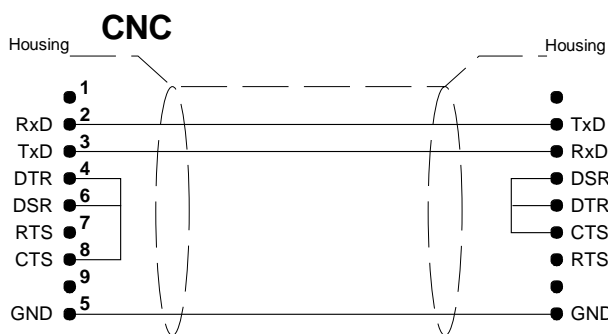

- Full connection

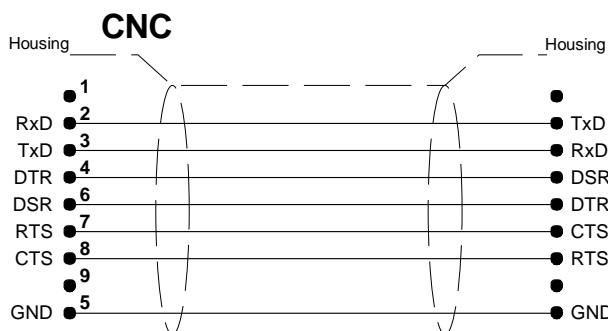

FAGOR AUTOMATION

CNC 8070

(REF: 1709)

4.12.3 RS422 serial line connection.

Connector pinout.

Plug-in part 9-pin female SUB-D type connector.

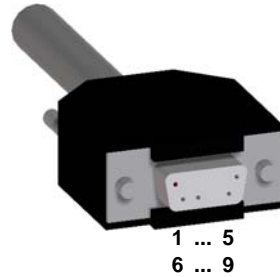

Pin.	Signal.	Description.
1	---	---
2	LineTerm	120Ωline terminating resistor.
3	LineTerm	120Ωline terminating resistor.
4	---	---
5	11	Reference signal.
6	TxD	Send data.
7	/TxD	Send data.
8	RxD	Receive data.
9	/RxD	Receive data.

The reserved pins must NOT be used in any case.

Cable characteristics.

Twisted-pair shielded cable should be used to minimize interference between cables, thus preventing poor communication in long lengths.

Characteristic.	
Type.	Shielded. Twisted-pair, with a minimum wire section of 0.20 mm ² (24 AWG).
Impedance.	120 Ω.
Maximum length.	15 m (50 ft).

Node connection.

Line terminating resistor.

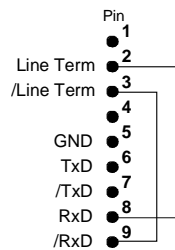

All the elements of the bus must have the line terminating resistor activated. The central unit has the resistor inside at pins 2 and 3; to activate it, jumper pin 2 with pin 8 and pin 3 with 9.

Interconnection of modules.

The cable shield must be connected to the connector at both ends. It is recommended to reference all the control and data signals to the same point (pin 5 GND), thus avoiding reference points with different voltages because there could be voltage differences in long lengths between the two ends of the cable.

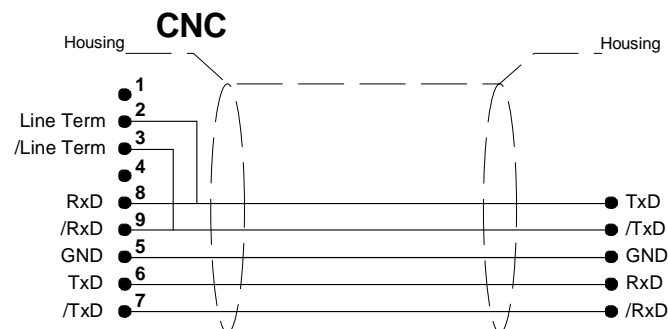

4.12.4 RS485 serial line connection.

Connector pinout.

Plug-in part 9-pin female SUB-D type connector.

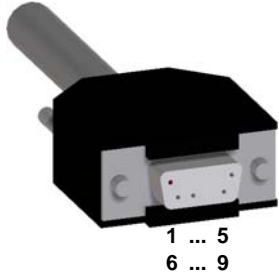

Pin.	Signal.	Description.
1	---	---
2	LineTerm	120Ωline terminating resistor.
3	LineTerm	120Ωline terminating resistor.
4	---	---
5	11	Reference signal.
6	TxD RxD	Data send/receive.
7	/TxD RxD	Data send/receive.
8	TxD RxD	Data send/receive.
9	/TxD RxD	Data send/receive.

Pins 6-8 and 7-9 are internally jumpered, thus either one can be used in the connection. The reserved pins must NOT be used in any case.

Cable characteristics.

Twisted-pair shielded cable should be used to minimize interference between cables, thus preventing poor communication in long lengths.

Characteristic.	
Type.	Shielded. Twisted-pair, with a minimum wire section of 0.20 mm ² (24 AWG).
Impedance.	120 Ω.
Maximum length.	15 m (50 ft).

Node connection.

Line terminating resistor.

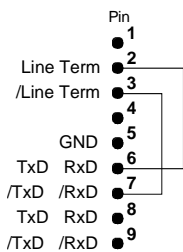

The elements located at the ends of the bus must have the line terminating resistor activated. The central unit has the resistor inside at pins 2 and 3; to activate it, jumper pin 2 with one of the pins 6/8 and pin 3 with one of the pins 7/9.

Interconnection of modules.

The cable shield must be connected to the connector at both ends. It is recommended to reference all the control and data signals to the same point (pin 5 GND), thus avoiding reference points with different voltages because there could be voltage differences in long lengths between the two ends of the cable.

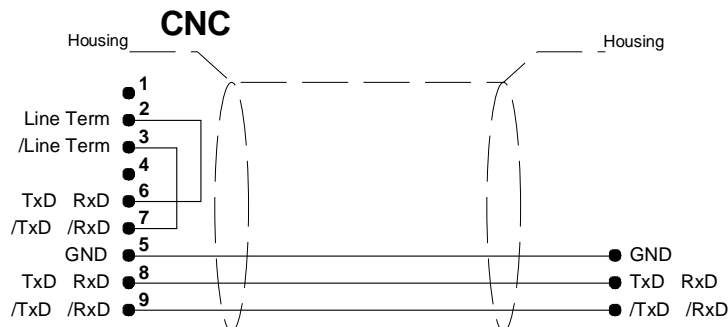

4.

C70-15 / C70-15T / C70-15A / C70-15AT / C70-10K U70♦.



FAGOR AUTOMATION

CNC 8070

(REF: 1709)

4.12.5 Feedback connection.

The central unit has 2 feedback inputs, valid for TTL and differential TTL signals.

Connector pinout.

Plug-in part 15-pin male SUB-D HD type connector.

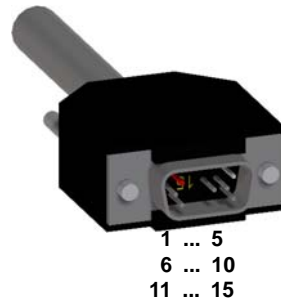

Pin.	Signal.	Description.
1	A	Feedback signals.
2	/A	
3	B	
4	/B	
5	I0	Reference signals.
6	/I0	
7	AL	Feedback alarm.
8	/AL	
9	+5 V DC	Voltage supply for the feedback system.
10	---	
11	11	0 V reference signal.
12	---	
13	---	
14	---	
15	Chassis(*)	Shield.

(*) Pin -15- is offered for compatibility. We recommend to connect the cable shield to the connector housing at both ends.

Cable characteristics.



Fagor Automation offers a wide range of cables and extension cables to connect the feedback systems to the CNC. The cable characteristics, as well as its length, depend on the type of feedback being used. Refer to our catalog for further information.

We recommend to run the feedback cables as far away as possible from the power cables of the machine.

The cable being used must have overall shield. The cable shield must be connected to the metallic hood at each end. The unshielded portion of the wires of an unshielded cable cannot be longer than 75 mm.

4.12.6 Connection to an Ethernet network (Fast Ethernet).

The Ethernet connection enables the CNC to be configured as another node in the local network, thus being able to communicate with other CNCs or PCs to transfer files, run telediagnoses, etc. The Ethernet connection also enables direct connection (point to point connection) to another CNC or PC.

Connector.

The RJ45 port has two LEDs to indicate whether the CNC is connected to the network (green LED) and if data are being transmitted (yellow LED).

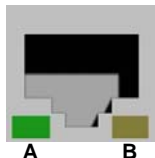

LED.	Meaning.
A (green)	Connection LED. The LED turns on when the CNC is connected to the data network.
B (yellow)	Activity LED. The LED blinks when data is being received/transferred.

Cable characteristics.

Use a specific Ethernet cable with the following characteristics.

Characteristic.	Description.
Type.	Standard shielded Ethernet 10Base-T cable (10/100 MHz connection). Use a crossed cable to connect for the point to point connection to the CNC.
Impedance.	10/100 MHz connection Cat.5 (100 Ω - 120 Ω) or greater.
Maximum length.	100 meters (328 ft).

Transmission speed.

The CNC permits a connection at 10 or 100 MHz; by default, it is configured for a connection at 10 MHz. Use a cable having the recommended characteristics to ensure a transmission at 100 MHz. Even so, since the transmission speed depends on the configuration of the network (number of nodes, their configuration, etc.) a 100 MHz transmission might not be stable. In these cases, we recommend to connect at 10 MHz,

Element connection.

In order to ensure proper performance, the connection cable must be inserted all the way into the connectors so they're latched. This ensures that the cable is properly latched and does not come off due to vibration.



C70-15 / C70-15T / C70-15A / C70-15AT / C70-10K U70 ♦



FAGOR AUTOMATION

CNC 8070

(REF: 1709)

4.

C70-15 / C70-15T / C70-15A / C70-15AT C70-10K U70♦.



CNC 8070

(REF: 1709)

5 LCD-15SVGA. PASSIVE MONITOR " LCD15-SVGA".



DISCONTINUED

The passive screen may be used to display the video signal coming from the ·VGA· connector of the central unit and also interact with the central unit using softkeys. This screen may be the only one connected to the central unit (for example, with the central unit MCU) or it may be a second monitor (for example, with the central unit ICU). When the screen is used as a second monitor, both monitors show the same video signal.

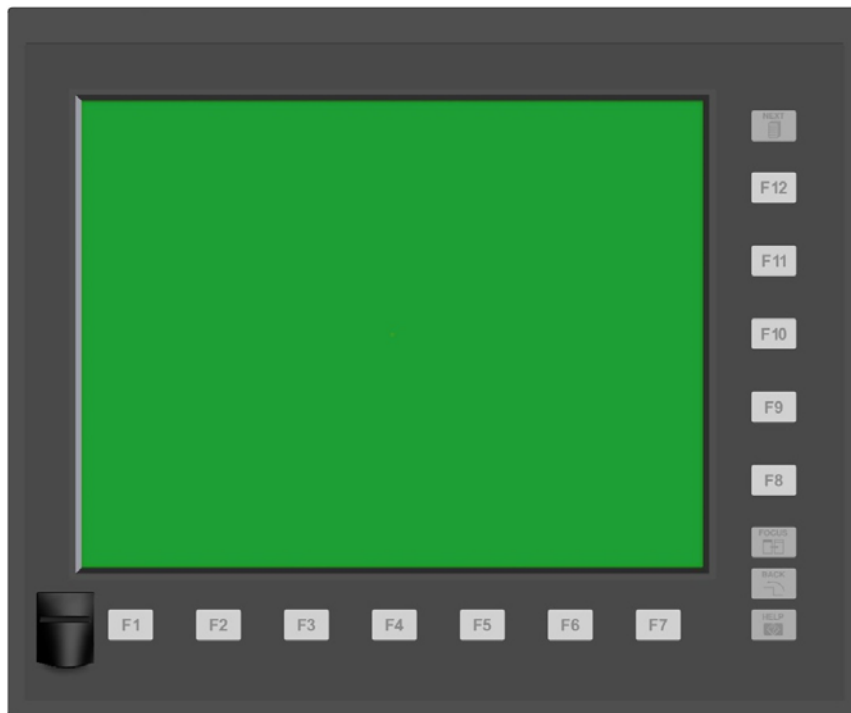

General characteristics.	
Power supply.	24 V DC universal power supply.
Connection.	Connect the screen to the ·VGA· output and the softkeys to the keyboard.
Degree of protection.	The face plate meets the IP 65 protection standard and the rear the IP 2X standard.

5.

LCD-15SVGA. PASSIVE MONITOR " LCD15-SVGA".



FAGOR AUTOMATION

CNC 8070

(REF: 1709)

5.1 Possible configurations.

The passive screen and the MCU central unit.

The passive screen permits having a work station consisting of the screen itself, a keyboard and an operator panel. Connect the softkeys of the screen to the keyboard and the -VGA- signal to the central unit. Connect the keyboard and the operator panel to the CAN bus of the system.

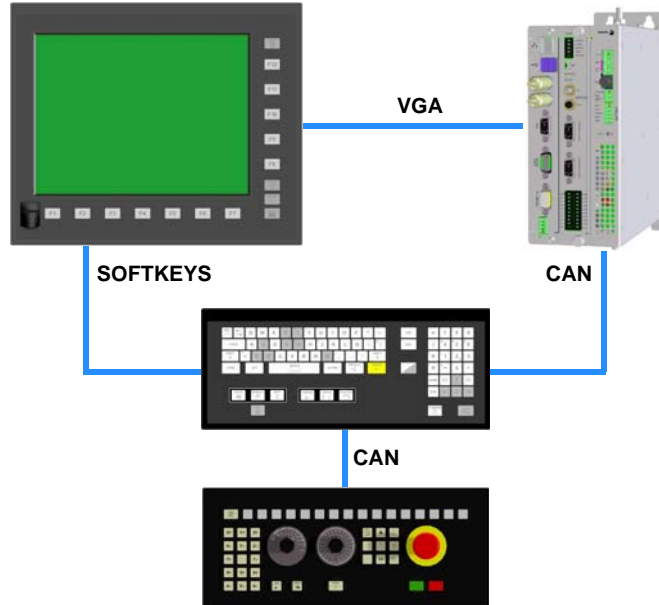

The passive screen and the ICU central unit.

The passive screen permits having a second work station consisting of the screen itself and an operator panel OP-PANEL-H/E. Connect the softkeys of the screen to the keyboard and the -VGA- signal to the central unit. Connect the keyboard and the operator panel to the CAN bus of the system.

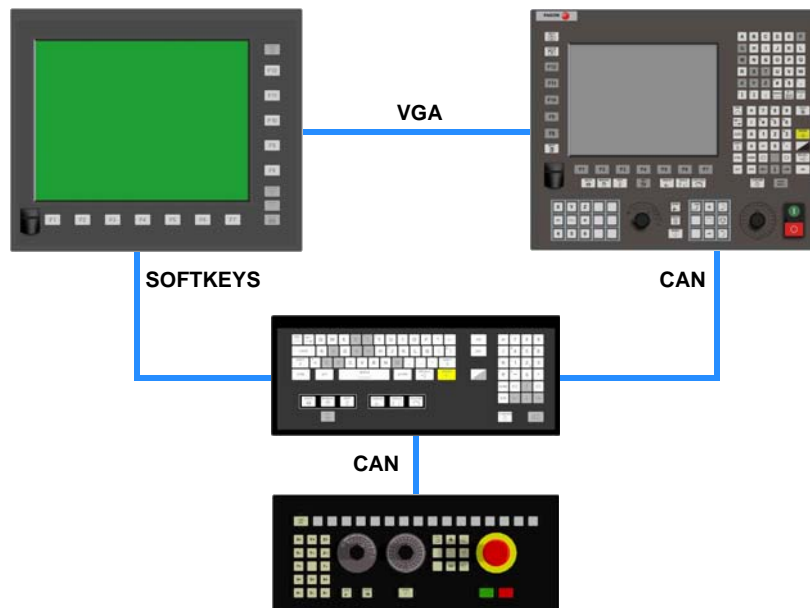

LCD-15SVGA. PASSIVE MONITOR " LCD15-SVGA".

5.2 Technical characteristics.

Electrical characteristics.

The unit has an internal power supply with the following characteristics.

Electrical characteristics.	
Input voltage.	24 V DC \pm 10% and 2 A.
Efficiency.	Greater than 80%.
Insulation.	1000 V DC; 1 minute.

Unit protections.

- Internal 5 A fuse.
- Protection against over-voltage peaks (higher than 36 V D) and reverse voltage. It is also protected against reverse connection of the power supply, preventing it from starting up.
- Protection against over-current.

Vibrations.

- Sweep sine trial with a frequency step of 1 octave/minute (\pm 10%) and 10 sweeps long.
 - 9 Hz $\geq f \geq$ 5 Hz Constant movement with an amplitude of 3.5 mm.
 - 150 Hz $\geq f \geq$ 9 Hz Constant 1g acceleration.

Packaging and resistance to falls.

- Packaging: Meets EN 60068-2-32 standard.
- Free fall packaged according to Fagor regulations (1 meter):

Ambient conditions.

- Relative humidity: 10-95% without condensation.
- Work temperature: 0-45 °C with an average lower than 35 °C.
- Storage temperature: Between -40 °C (77 °F) and +70 °C (158 °F).
- Maximum work altitude: IEC 1131-2 compliant.

Degree of protection.

- Front panel: It meets the protection standard IP 65.
- Rear panel: It meets the protection standard IP 2X.



Do not get into the inside of the unit. This unit MUST NOT be opened by unauthorized personnel. Only personnel authorized by Fagor Automation may access the interior of this unit.

5.

LCD-15SVGA. PASSIVE MONITOR " LCD15-SVGA ".

FAGOR

FAGOR AUTOMATION

CNC 8070

(REF: 1709)

5.3 Hardware dimensions.

5.

LCD-15SVGA. PASSIVE MONITOR " LCD15-SVGA".

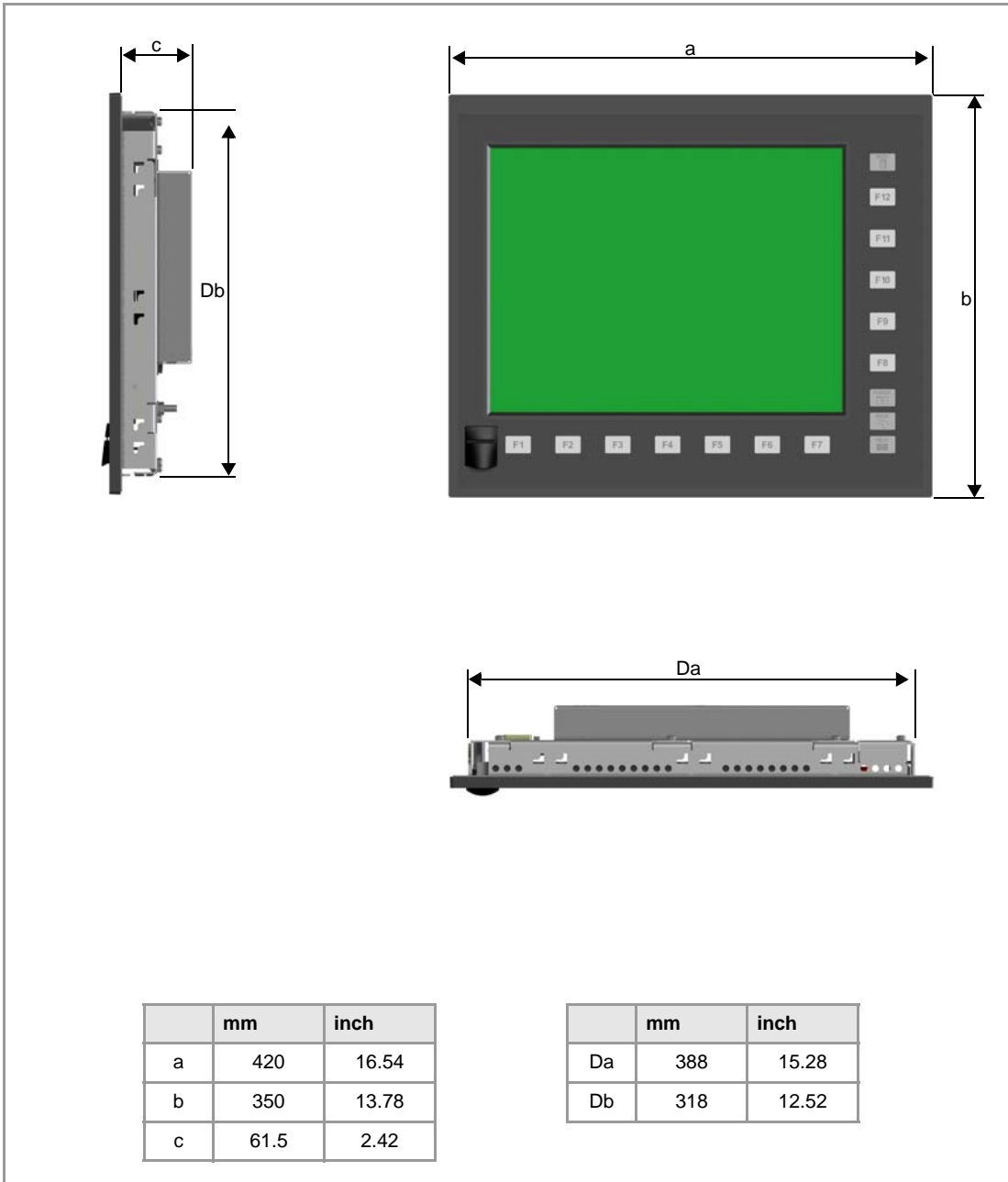

FAGOR AUTOMATION

CNC 8070

(REF: 1709)

5.4 Dimensions and characteristics of the enclosure.

5.4.1 Enclosure design.

The enclosure must meet the following requirements:

- Keep the enclosure clean. If the enclosure has ventilation holes, anti-dust filters should be installed in all of them.
- Reserve some room for the laying out cables in the connector area. This space must allow for the connection of cables, while accounting for their bending radius.
- The cabinet must consider the minimum recommended distances between the enclosure walls and the hardware to let the air flow and improve heat dissipation.



To meet the previous requirements, Fagor recommends the following.

- The enclosure must not have any ventilation holes, because they could let dust or other substances in.
- To improve heat dissipation, install a fan inside the enclosure for air circulation.



Before building an enclosure with glass fiber u another poor heat dissipating material, contact Fagor Automation.

Dimensions of the cut off part and the enclosure.

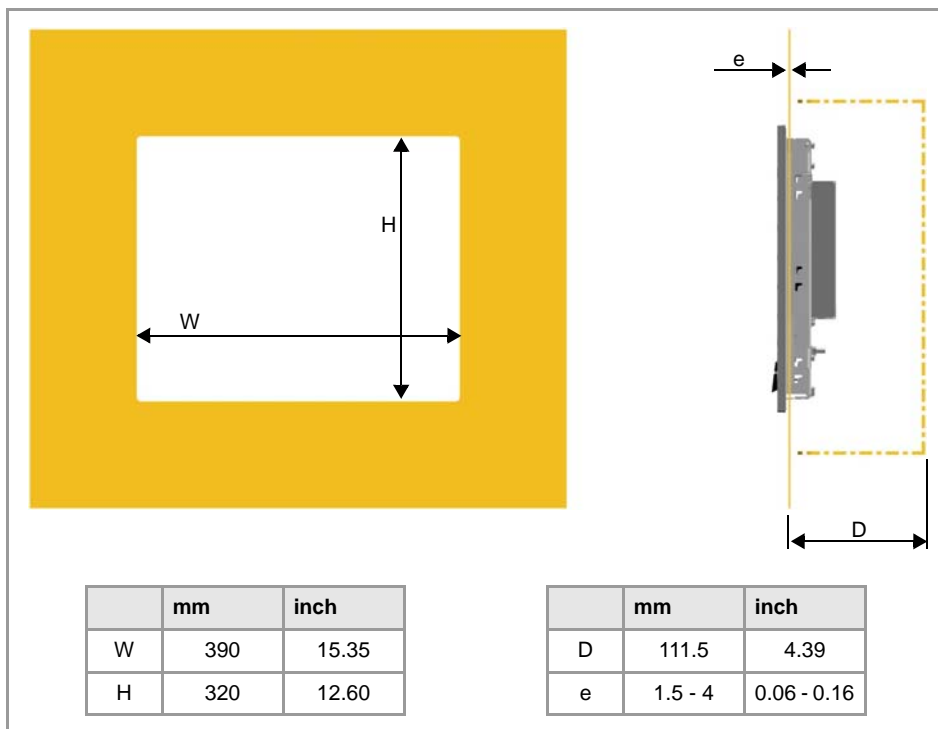

5.

LCD-15SVGA. PASSIVE MONITOR " LCD15-SVGA".

FAGOR

FAGOR AUTOMATION

CNC 8070

(REF: 1709)

5.4.2 Securing the module.

The module must be installed in a proper enclosure that may be located on the machine or on an external support. To insert the unit into the enclosure, it must have a big enough hole to allow to insert it easily, without obstacles and without forcing the unit. See "5.4.1 Enclosure design." on page 83.

The module is mounted from inside the enclosure. Once the unit has been inserted into the enclosure, secure it from the inside with the tension jacks. To properly secure it, use all the tension jacks on the back of the unit. Apply a tightening torque of 0.7 Nm.

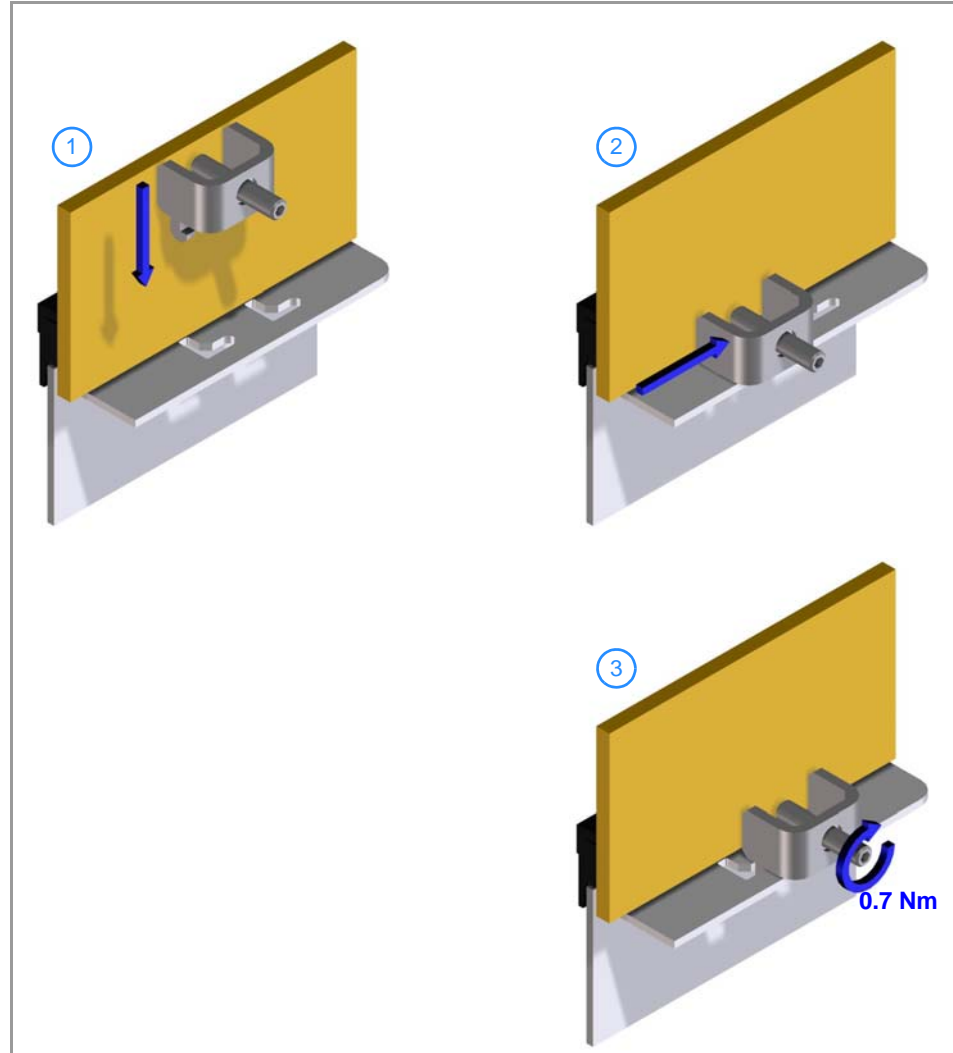
**5.**

LCD-15SVGA. PASSIVE MONITOR " LCD15-SVGA".



FAGOR AUTOMATION

CNC 8070

(REF: 1709)

5.5 Elements (connectors).

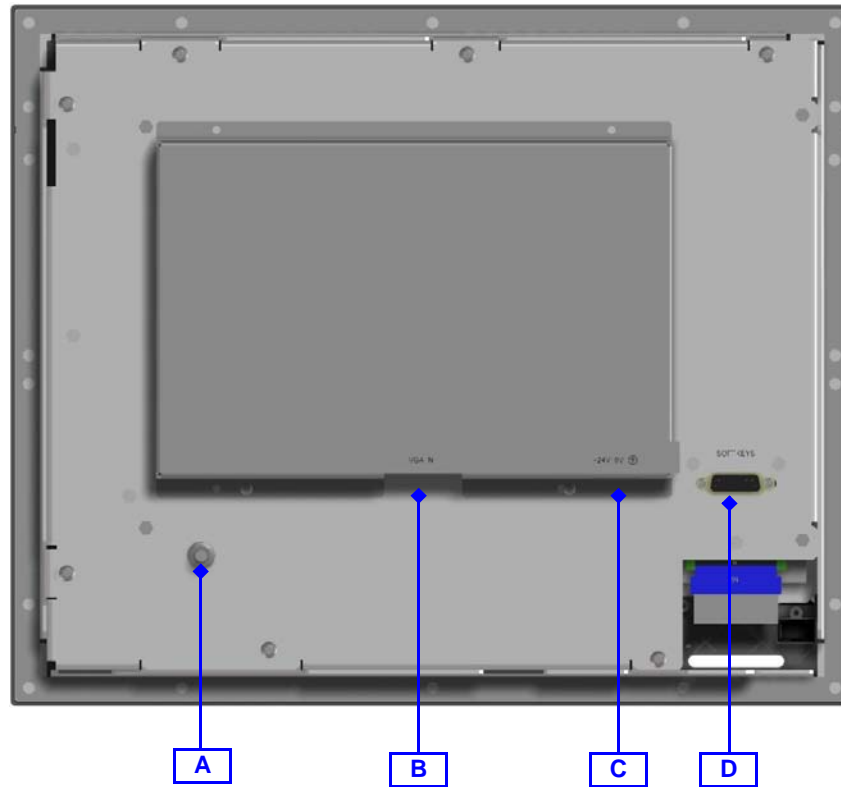

Connector.	
·A·	Ground.
·B·	VGA input.
·C·	24 V supply input.
·D·	Softkeys.

5.

LCD-15SVGA. PASSIVE MONITOR " LCD15-SVGA".

FAGOR 

FAGOR AUTOMATION

CNC 8070

(REF: 1709)

Ground connection.

Remember that the ground terminals of all the elements making up the system must be connected to a single ground point.

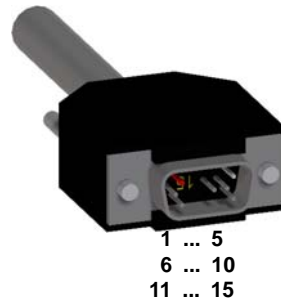
-VGA- connector.

Plug-in part 15-pin male SUB-D HD type connector.

Pin.	Signal.
1	MAINS
2	GREEN
3	BLUE
4	- - -
5	11
6	GND_RED
7	GND_GREEN
8	GND_BLUE
9	- - -
10	GND_SYNC
11	- - -
12	- - -
13	HSYNC
14	VSYNC
15	- - -

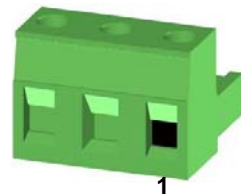
24 V DC voltage supply.

Plug-in part 3-pole Phoenix-type combicon connector (7.62 mm pitch).

Pin	Signal.	Function.
1		Chassis.
2	11	0 V reference signal.
3	+24 V	Power supply.

Softkeys.

Connection of the softkeys of the monitor to the keyboard. Maximum cable length is 1 meter.

5.

LCD-15SVGA. PASSIVE MONITOR " LCD15-SVGA".

5.6 Overall connection.

Power supply.

The passive screen is powered by an external DC power supply; use a 24 V DC $\pm 10\%$ and 2 A. power supply.

VGA video signal.

Use the VGA output of the central unit. The connection is parallel, 1 with 1, 2 with 2, etc. The cable shield must be connected to the connector at both ends.

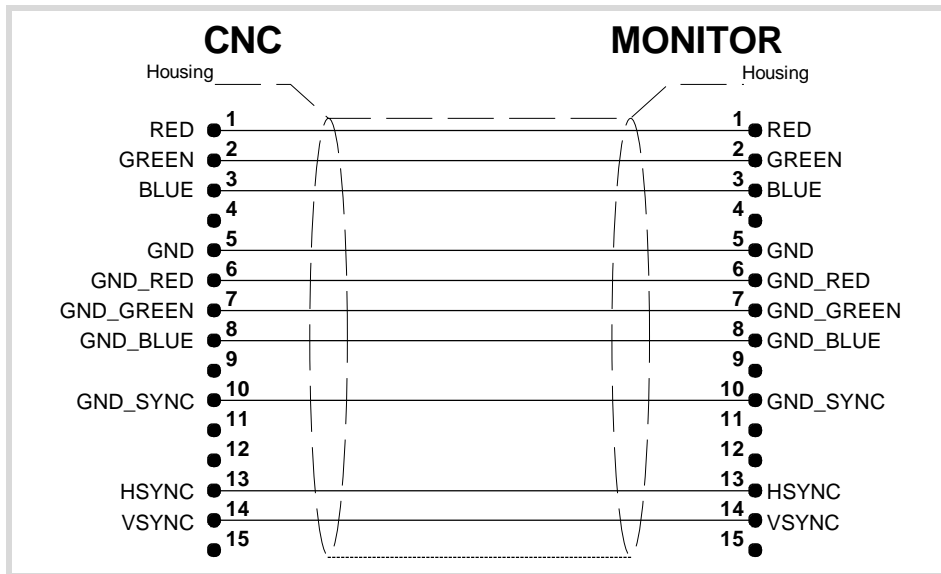

Cable characteristics.

Use specific VGA cable.

-VGA- cable.	
Flexibility.	Normal.
Type.	Shielded.
Impedance.	75 Ω .
Maximum length.	30 m.



Fagor Automation supplies the necessary cable for the VGA connection. The cable is valid for static installations such as cable carrying chains. For further information, refer to the Ordering Handbook.

5.

LCD-15SVGA. PASSIVE MONITOR " LCD15-SVGA".

FAGOR

FAGOR AUTOMATION

CNC 8070

(REF: 1709)

5.

LCD-15SVGA. PASSIVE MONITOR " LCD15-SVGA ".

FAGOR 
FAGOR AUTOMATION

CNC 8070

(REF: 1709)

6 HORIZONTAL KEYB / HORIZONTAL KEYB+MOUSE.



The machine manufacturer must comply with the EN 60204-1 (IEC-204-1) regulation regarding electrical shocks in case of defective input/output pins with external power supply when not plugging the connector before turning the power supply on.

Module.	Description.
HORIZONTAL KEYB	CAN horizontal, alphanumeric QWERTY keyboard.
HORIZONTAL KEYB+MOUSE	CAN horizontal, alphanumeric QWERTY keyboard with mouse.

HORIZONTAL KEYB



HORIZONTAL KEYB+MOUSE



6.1 Specifications.

Type.	Description.
General.	<ul style="list-style-type: none"> • CAN horizontal, alphanumeric QWERTY keyboard. • CAN horizontal, alphanumeric QWERTY keyboard with mouse. • "Spanish (Spain)"; keyboard layout. • Dimensions (width x height x depth) <ul style="list-style-type: none"> - 420 x 175 x 24 mm. - 16.54" x 6.89" x 0.94".
Safety.	<ul style="list-style-type: none"> • CE
Ambient.	<ul style="list-style-type: none"> • Degree of protection: IP65 (front panel).
Power supply.	<ul style="list-style-type: none"> • 24 V DC universal power supply, via Phoenix connector.
Connectivity.	<ul style="list-style-type: none"> • Connection to the central unit through CAN bus (keyboard) and PS-2 (mouse).

6.

HORIZONTAL KEYB / HORIZONTAL KEYB+MOUSE.



FAGOR AUTOMATION

CNC 8070

(REF: 1709)

6.2 General diagram.

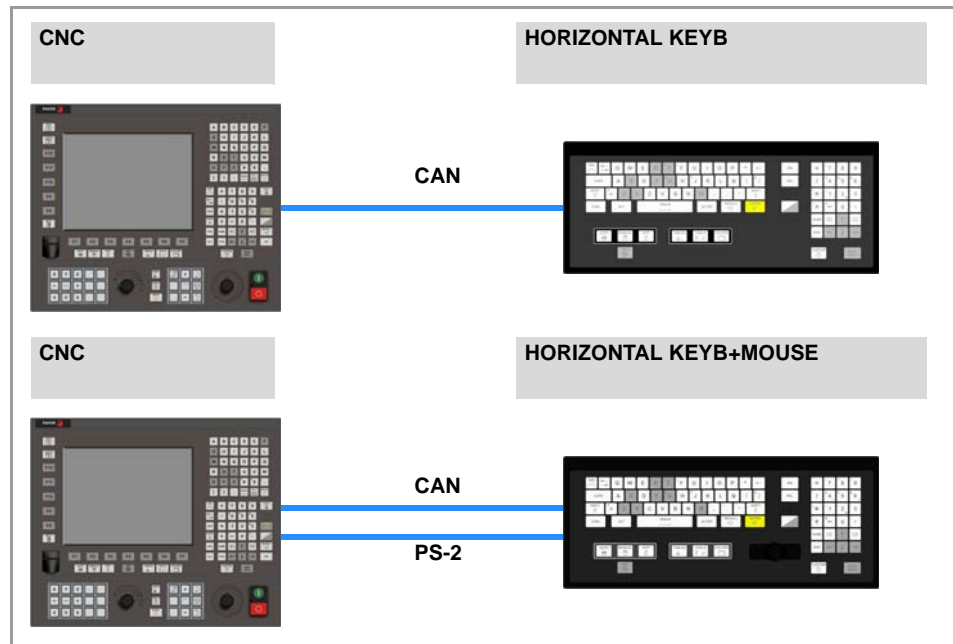

Connection.	Description.
CAN	Communication with CNC. Maximum length: 500 m (1640 ft) for the CANopen bus.

HORIZONTAL KEYB / HORIZONTAL KEYB+MOUSE.

6.3 Dimensions.

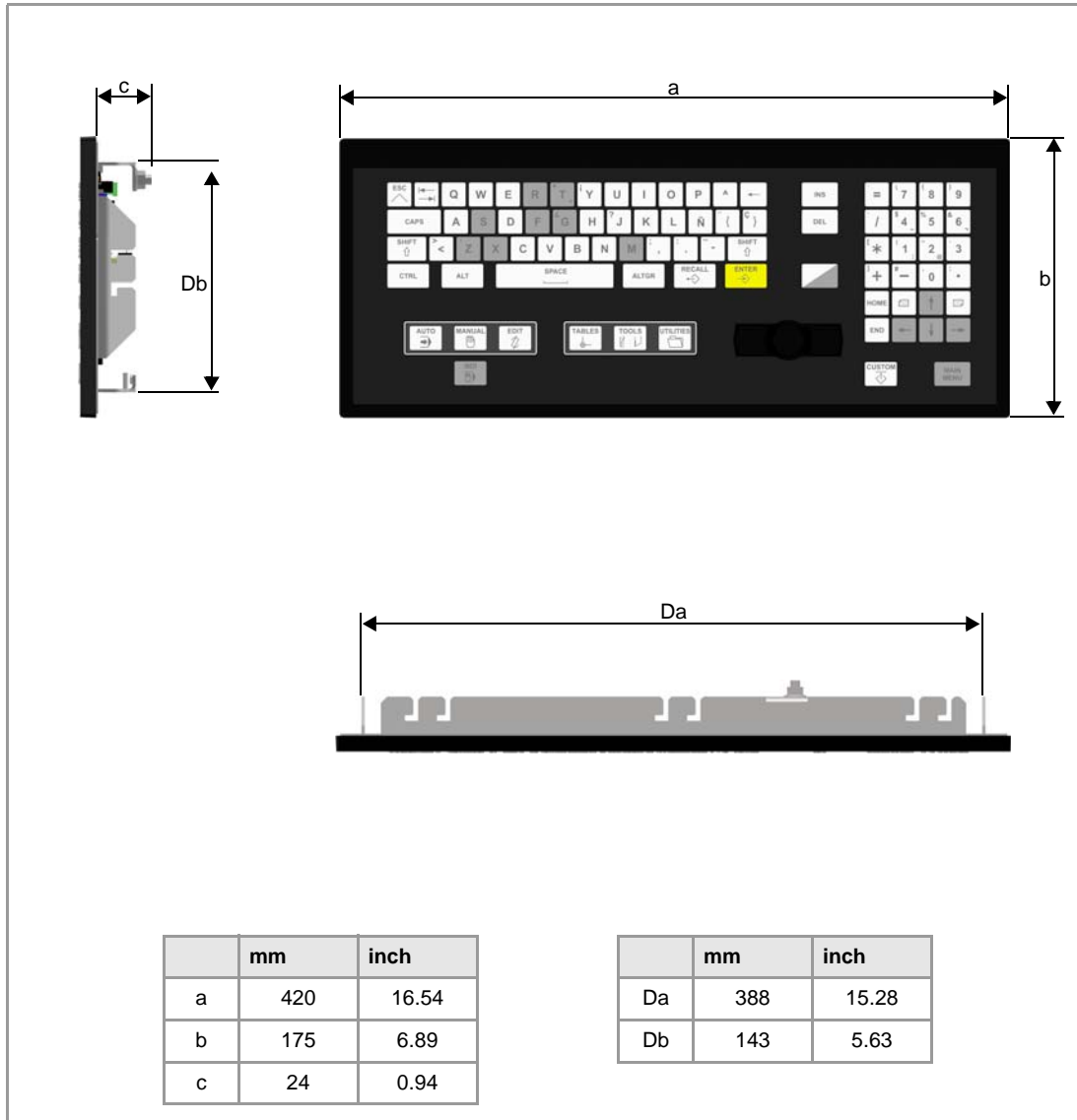

6.

HORIZONTAL KEYB / HORIZONTAL KEYB+MOUSE:



FAGOR AUTOMATION

CNC 8070

(REF: 1709)

6.4 Enclosure and mounting of the module.

6.4.1 Enclosure design.

The enclosure must meet the following requirements:

- Keep the enclosure clean. If the enclosure has ventilation holes, anti-dust filters should be installed in all of them.
- Reserve some room for the laying out cables in the connector area. This space must allow for the connection of cables, while accounting for their bending radius.
- The cabinet must consider the minimum recommended distances between the enclosure walls and the hardware to let the air flow and improve heat dissipation.



To meet the previous requirements, Fagor recommends the following.

- The enclosure must not have any ventilation holes, because they could let dust or other substances in.
- To improve heat dissipation, install a fan inside the enclosure for air circulation.



Before building an enclosure with glass fiber or another poor heat dissipating material, contact Fagor Automation.

Dimensions of the cut off part and the enclosure.

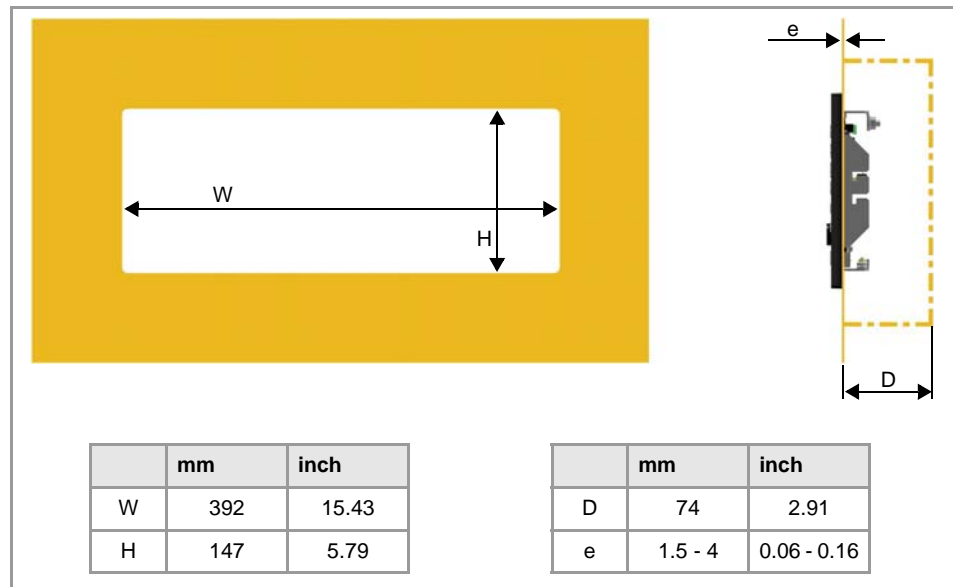

HORIZONTAL KEYB / HORIZONTAL KEYB+MOUSE.



FAGOR AUTOMATION

CNC 8070

(REF: 1709)

6.4.2 Securing the module.

The module must be installed in a proper enclosure that may be located on the machine or on an external support. To insert the unit into the enclosure, it must have a big enough hole to allow to insert it easily, without obstacles and without forcing the unit. See "6.4.1 Enclosure design." on page 92.

The module is mounted from inside the enclosure. Once the unit has been inserted into the enclosure, secure it from the inside with the tension jacks. To properly secure it, use all the tension jacks on the back of the unit. Apply a tightening torque of 0.7 Nm.

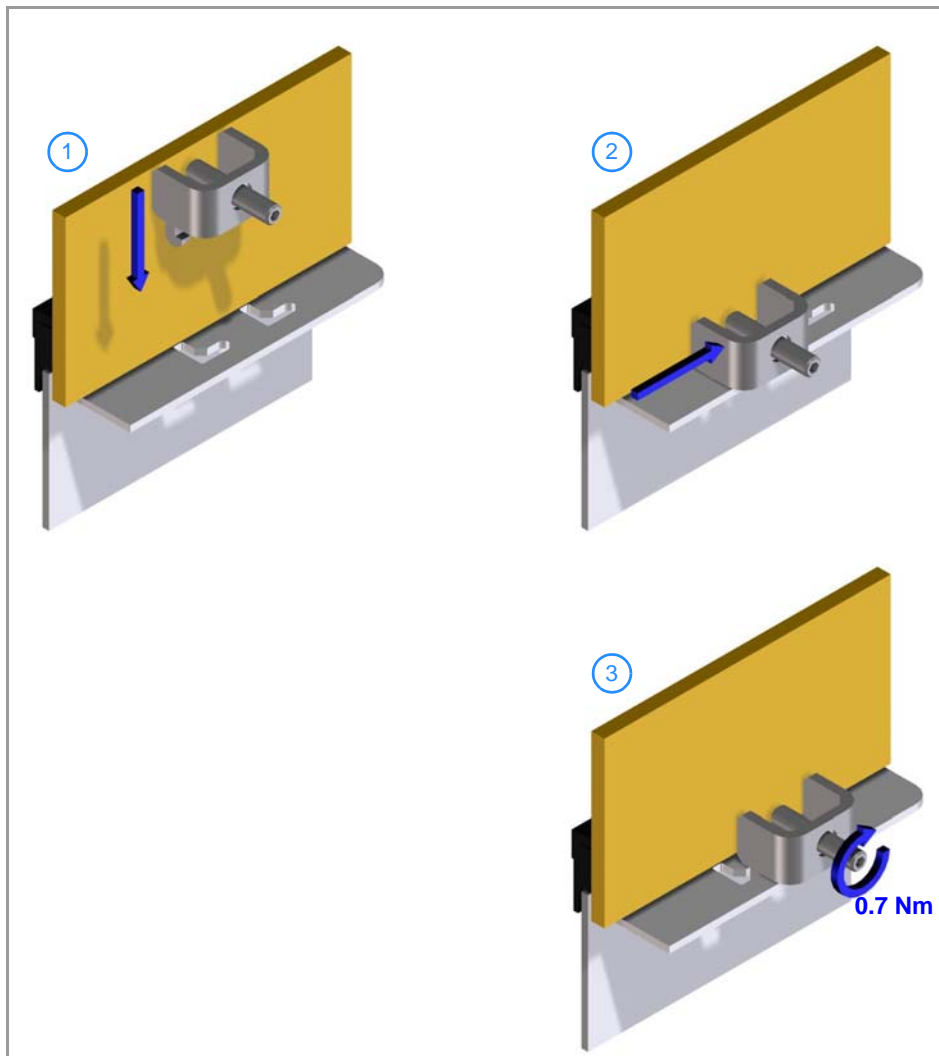

6.

HORIZONTAL KEYB / HORIZONTAL KEYB+MOUSE:

FAGOR 

FAGOR AUTOMATION

CNC 8070

(REF: 1709)

6.5 Hardware functionalities.

6.5.1 Ground connection.



It is up to the system integrator to meet all the requirements of local and national electrical codes as well as all the regulations applicable regarding the grounding of the whole unit.

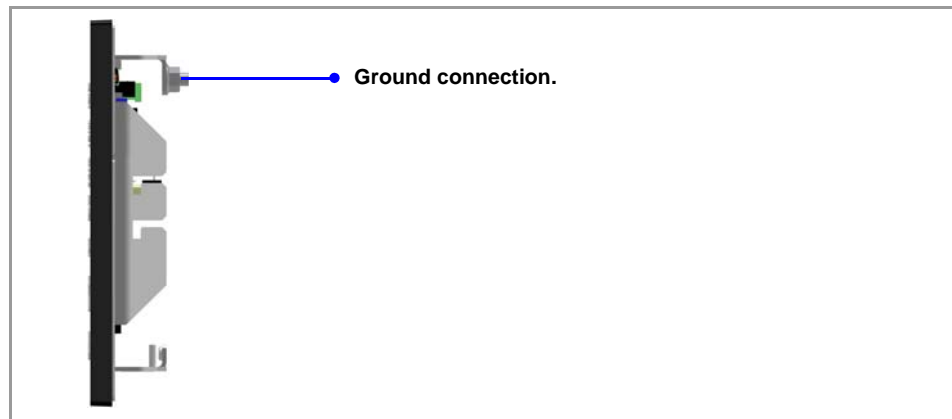

6.5.2 Rear connectors.

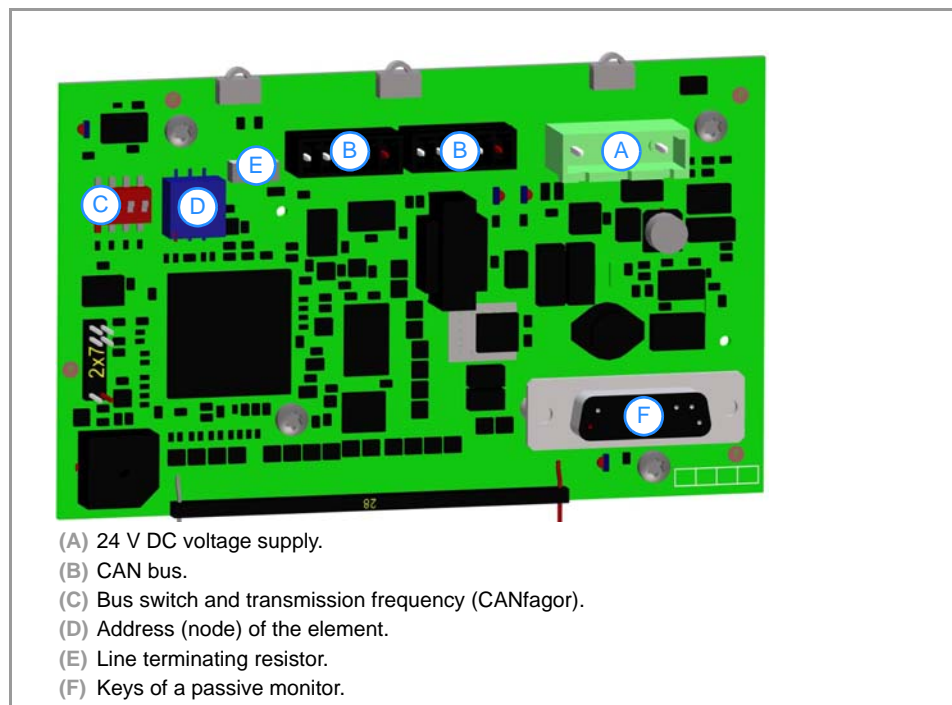

6.

HORIZONTAL KEYB / HORIZONTAL KEYB+MOUSE.



FAGOR AUTOMATION

CNC 8070

(REF: 1709)

Keys of a passive monitor.

Connection of the keys of the LCD15 passive monitor. Maximum cable length is 1 meter.

Power supply.

3-pin male Phoenix combicom contact (7.62 mm pitch).

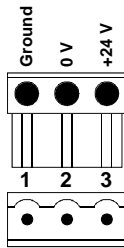

Signal.	Function.
Ground.	Ground.
0 V	Power supply.
+24 V	Power supply.

Connector to power the keyboard with universal 24 V DC.

CAN bus. -CAN- connector.

5-pin male Phoenix minicombicon contact (3.5 mm pitch).

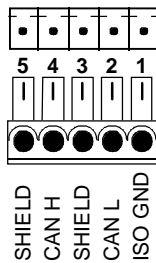

Pin.	Signal.	Function.
1	ISO GND	Ground / 0 V.
2	CAN L	(LOW) bus signal.
3	SHIELD	CAN shield.
4	CAN H	(HIGH) bus signal.
5	SHIELD	CAN shield.

CAN bus. -ADDRESS- selector. Address (node) of the element within the bus.



Each one of the elements integrated into the CAN bus is identified by the 16-position rotary switch (0-15) "Address" (also referred to as "Node_Select"). With the ADD MSB" switch, the positions or elements integrated in the CAN bus may be expanded up to 32.

The CNC must always occupy position "0" and the rest of the elements of the bus will occupy consecutive positions starting with 1. In order for any change at the "Address" switch to be assumed, the CNC must be restarted and the corresponding drive must be reset, however, we recommend to change the address while the modules and the CNC are off.

The "Address" switch also sets the priority of the group within the bus; the lower the number the higher the priority. We recommend the keyboard and jog panel to be the last node of the bus.

CAN bus. -ADD MSB- selector Address (node) of the element within the bus.

With the -4- switch (ADD MSB), the positions or elements integrated in the CAN bus may be expanded up to 32. Positions 0-15 are selected with ADD MSB=0 and positions 16-31 with ADD MSB=1.

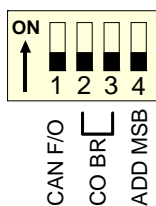

DS -4-	Address (node) of the element.
off	Positions 0-15 within the bus.
on	Positions 16-31 within the bus.

CAN bus. Bus type selector: CANfagor / CANopen.

Switch ·1· (CAN F/O) selects the type of CAN bus to be used, i.e. CANfagor or CANOpen.

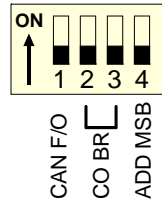

DS ·1·	Type of CAN bus.
off	The CANfagor bus has been selected.
on	The CANopen bus has been selected.

CAN bus. Selecting the speed for the CANopen bus.

When using the CANopen protocol, the transmission speed at the bus is defined in each node and they all must run at the same speed. The speed is selected with switches ·2· and ·3· (CO BR).

The transmission speed depends on the total length of the bus. Using the following illustrative values; assigning other values may cause communication errors due to signal distortion.

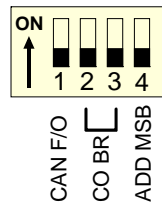

DS ·2·	DS ·3·	Speed	Length of the CAN bus.
on	on	1000 kHz	Up to 20 meters.
off	on	800 kHz	From 20 to 40 meters.
on	off	500 kHz	From 40 to 100 meters.
off	off	250 kHz	From 100 to 500 meters.

In order for any change of speed to be assumed, the corresponding module must be reset; however, we recommend to change the speed while the modules and the CNC are off.

CAN bus. ·LT· selector.

Line terminating resistor. The ·LT· switch identifies which are the elements that occupy the ends of the CAN bus; i.e. the first and last physical element in the connection.

The switch position of the terminating elements must be "1" and that of the rest of the elements "0".

7 VERTICAL KEYB / VERTICAL KEYB+MOUSE.



The machine manufacturer must comply with the EN 60204-1 (IEC-204-1) regulation regarding electrical shocks in case of defective input/output pins with external power supply when not plugging the connector before turning the power supply on.

Module.	Description.
VERTICAL KEYB	CAN vertical, alphanumeric QWERTY keyboard.
VERTICAL KEYB+MOUSE	CAN vertical, alphanumeric QWERTY keyboard with mouse.

VERTICAL KEYB

VERTICAL KEYB+MOUSE



7.

VERTICAL KEYB / VERTICAL KEYB+MOUSE.

7.1 Specifications.

Type.	Description.
General.	<ul style="list-style-type: none"> • CAN vertical, alphanumeric QWERTY keyboard. • CAN vertical, alphanumeric QWERTY keyboard with mouse. • "Spanish (Spain)"; keyboard layout. • Dimensions (width x height x depth) <ul style="list-style-type: none"> - 153 x 350 x 24 mm. - 6.02" x 13.78" x 0.94".
Safety.	<ul style="list-style-type: none"> • CE
Ambient.	<ul style="list-style-type: none"> • Degree of protection: IP65 (front panel).
Power supply.	<ul style="list-style-type: none"> • 24 V DC universal power supply, via Phoenix connector.
Connectivity.	<ul style="list-style-type: none"> • Connection to the central unit through CAN bus (keyboard) and PS-2 (mouse).



FAGOR AUTOMATION

CNC 8070

(REF: 1709)

7.2 General diagram.

7.

VERTICAL KEYB / VERTICAL KEYB+MOUSE.

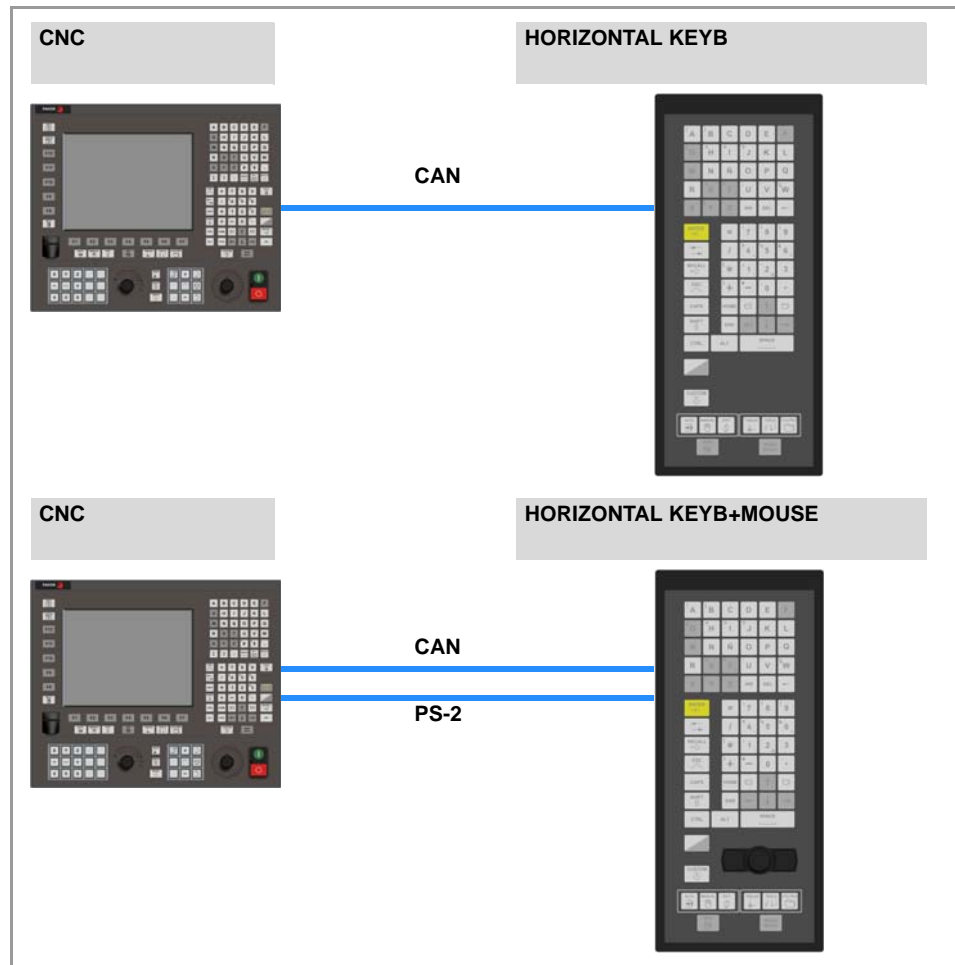

Connection.	Description.
CAN	Communication with CNC. Maximum length: 500 m (1640 ft) for the CANopen bus.

7.3 Dimensions.

	mm	inch
a	153	6.02
b	350	13.78
c	24	0.94

	mm	inch
Da	121	4.76
Db	318	12.52

7.

VERTICAL KEYB / VERTICAL KEYB+MOUSE.



FAGOR AUTOMATION

CNC 8070

(REF: 1709)

7.4 Enclosure and mounting of the module.

7.4.1 Enclosure design.

The enclosure must meet the following requirements:

- Keep the enclosure clean. If the enclosure has ventilation holes, anti-dust filters should be installed in all of them.
- Reserve some room for the laying out cables in the connector area. This space must allow for the connection of cables, while accounting for their bending radius.
- The cabinet must consider the minimum recommended distances between the enclosure walls and the hardware to let the air flow and improve heat dissipation.



To meet the previous requirements, Fagor recommends the following.

- The enclosure must not have any ventilation holes, because they could let dust or other substances in.
- To improve heat dissipation, install a fan inside the enclosure for air circulation.



Before building an enclosure with glass fiber or another poor heat dissipating material, contact Fagor Automation.

Dimensions of the cut off part and the enclosure.

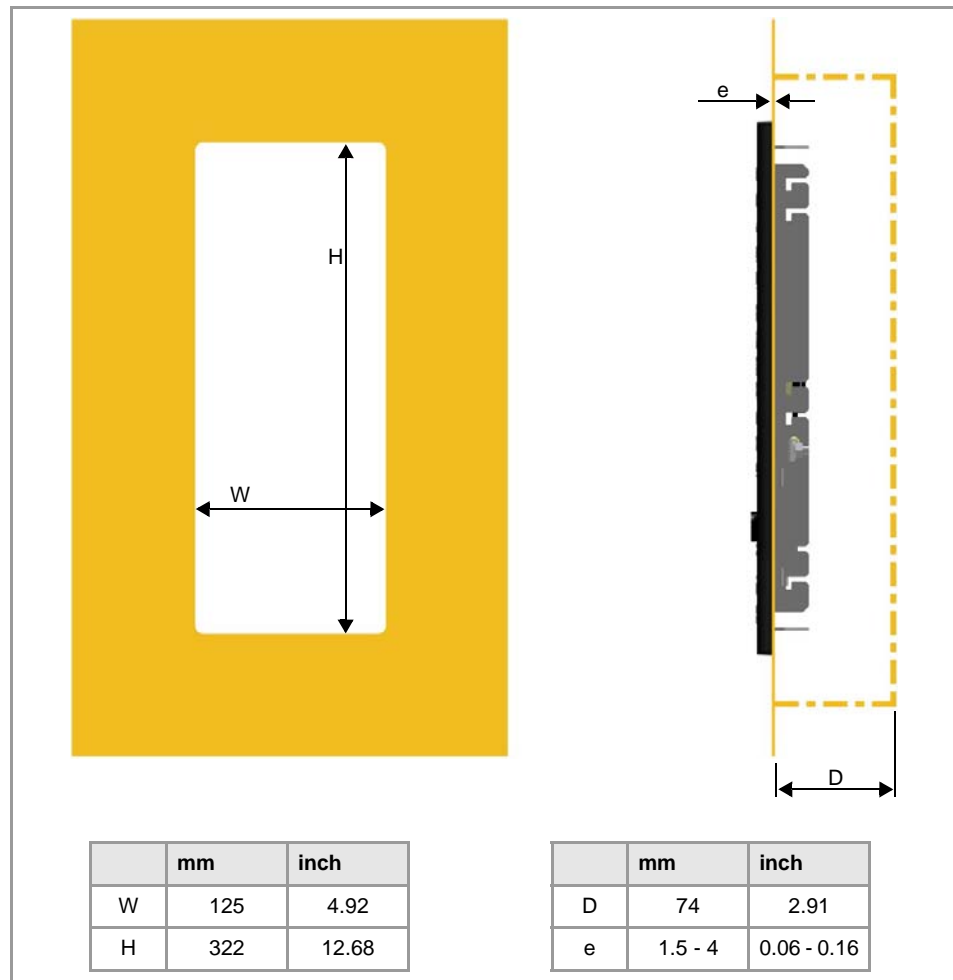

VERTICAL KEYB / VERTICAL KEYB+MOUSE.



FAGOR AUTOMATION

CNC 8070

(REF: 1709)

7.4.2 Securing the module.

The module must be installed in a proper enclosure that may be located on the machine or on an external support. To insert the unit into the enclosure, it must have a big enough hole to allow to insert it easily, without obstacles and without forcing the unit. See "7.4.1 Enclosure design." on page 100.

The module is mounted from inside the enclosure. Once the unit has been inserted into the enclosure, secure it from the inside with the tension jacks. To properly secure it, use all the tension jacks on the back of the unit. Apply a tightening torque of 0.7 Nm.

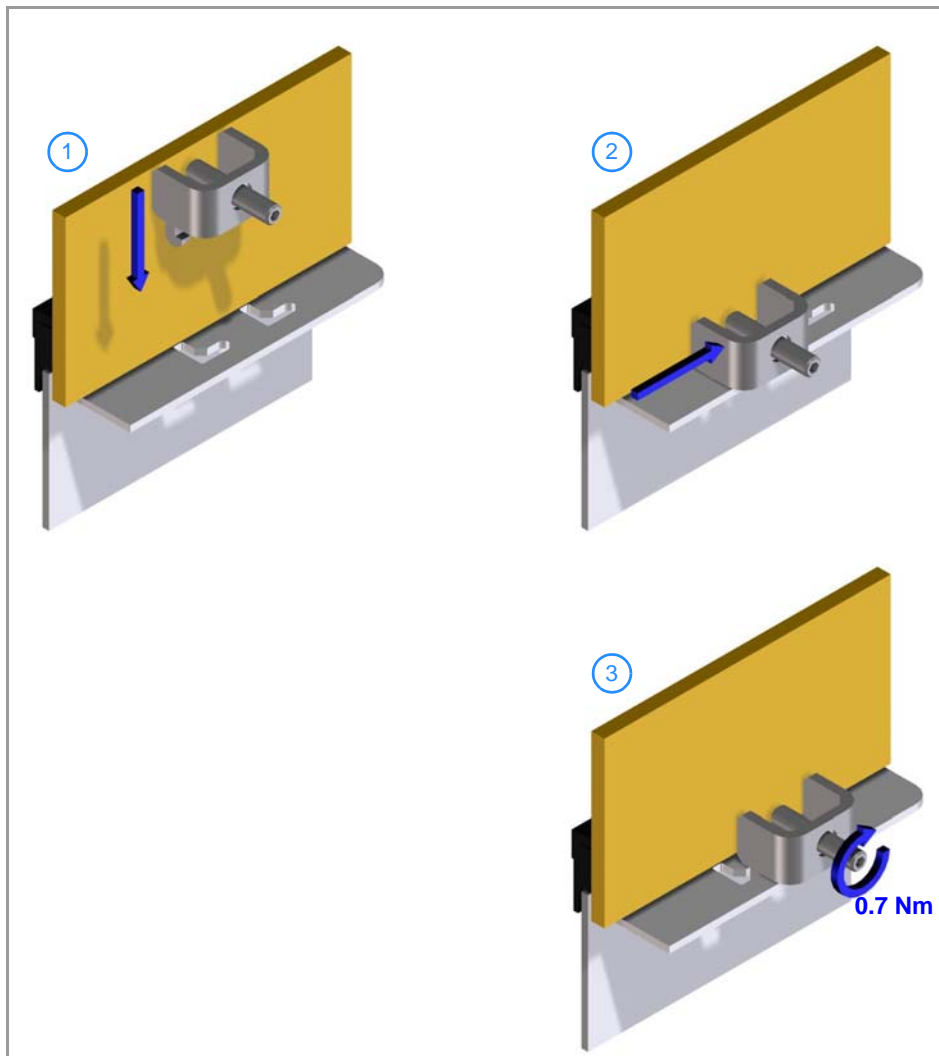

7.

VERTICAL KEYB / VERTICAL KEYB+MOUSE:

FAGOR 

FAGOR AUTOMATION

CNC 8070

(REF: 1709)

7.5 Hardware functionalities.

7.5.1 Ground connection.



It is up to the system integrator to meet all the requirements of local and national electrical codes as well as all the regulations applicable regarding the grounding of the whole unit.

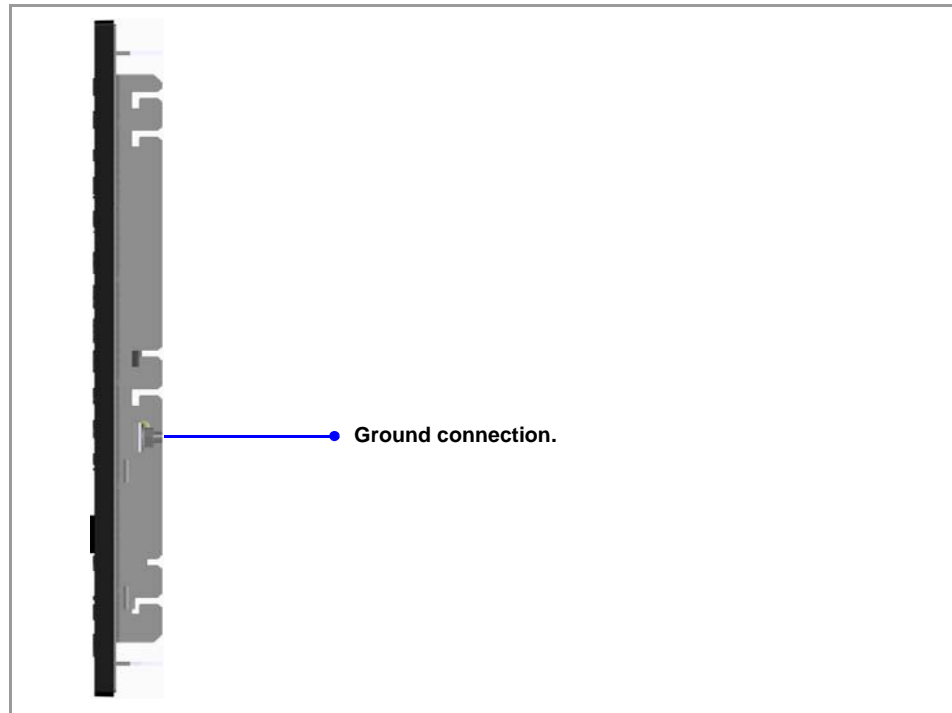

7.5.2 Rear connectors.

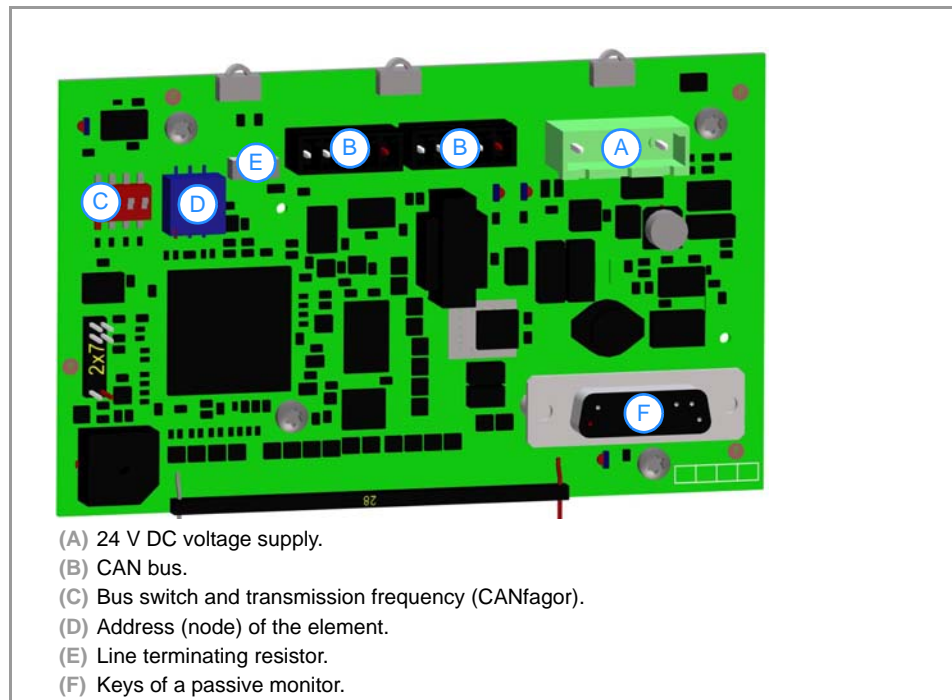

7.

VERTICAL KEYB / VERTICAL KEYB+MOUSE.

Keys of a passive monitor.

Connection of the keys of the LCD15 passive monitor. Maximum cable length is 1 meter.

Power supply.

3-pin male Phoenix combicom contact (7.62 mm pitch).

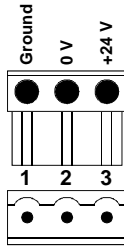

Signal.	Function.
Ground.	Ground.
0 V	Power supply.
+24 V	Power supply.

Connector to power the keyboard with universal 24 V DC.

CAN bus. -CAN- connector.

5-pin male Phoenix minicombicon contact (3.5 mm pitch).

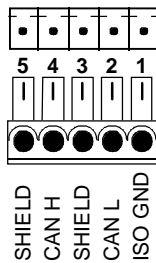

Pin.	Signal.	Function.
1	ISO GND	Ground / 0 V.
2	CAN L	(LOW) bus signal.
3	SHIELD	CAN shield.
4	CAN H	(HIGH) bus signal.
5	SHIELD	CAN shield.

CAN bus. -ADDRESS- selector. Address (node) of the element within the bus.



Each one of the elements integrated into the CAN bus is identified by the 16-position rotary switch (0-15) "Address" (also referred to as "Node_Select"). With the ADD MSB" switch, the positions or elements integrated in the CAN bus may be expanded up to 32.

The CNC must always occupy position "0" and the rest of the elements of the bus will occupy consecutive positions starting with 1. In order for any change at the "Address" switch to be assumed, the CNC must be restarted and the corresponding drive must be reset, however, we recommend to change the address while the modules and the CNC are off.

The "Address" switch also sets the priority of the group within the bus; the lower the number the higher the priority. We recommend the keyboard and jog panel to be the last node of the bus.

CAN bus. -ADD MSB- selector Address (node) of the element within the bus.

With the -4- switch (ADD MSB), the positions or elements integrated in the CAN bus may be expanded up to 32. Positions 0-15 are selected with ADD MSB=0 and positions 16-31 with ADD MSB=1.

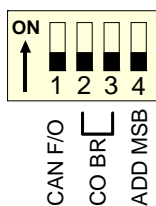

DS -4-	Address (node) of the element.
off	Positions 0-15 within the bus.
on	Positions 16-31 within the bus.



VERTICAL KEYB / VERTICAL KEYB+MOUSE:



FAGOR AUTOMATION

CNC 8070

(REF: 1709)

CAN bus. Bus type selector: CANfagor / CANopen.

Switch ·1· (CAN F/O) selects the type of CAN bus to be used, i.e. CANfagor or CANOpen.

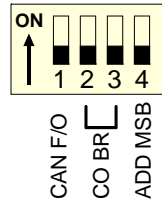

DS ·1·	Type of CAN bus.
off	The CANfagor bus has been selected.
on	The CANopen bus has been selected.

CAN bus. Selecting the speed for the CANopen bus.

When using the CANopen protocol, the transmission speed at the bus is defined in each node and they all must run at the same speed. The speed is selected with switches ·2· and ·3· (CO BR).

The transmission speed depends on the total length of the bus. Using the following illustrative values; assigning other values may cause communication errors due to signal distortion.

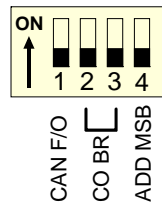

DS ·2·	DS ·3·	Speed	Length of the CAN bus.
on	on	1000 kHz	Up to 20 meters.
off	on	800 kHz	From 20 to 40 meters.
on	off	500 kHz	From 40 to 100 meters.
off	off	250 kHz	From 100 to 500 meters.

In order for any change of speed to be assumed, the corresponding module must be reset; however, we recommend to change the speed while the modules and the CNC are off.

CAN bus. ·LT· selector.

Line terminating resistor. The ·LT· switch identifies which are the elements that occupy the ends of the CAN bus; i.e. the first and last physical element in the connection.

The switch position of the terminating elements must be "1" and that of the rest of the elements "0".

8 HORIZONTAL KEYB 2.0 + TOUCHPAD.

Model.	Description.
HORIZONTAL KEYB 2.0 + TOUCHPAD	<ul style="list-style-type: none"> • USB horizontal, alphanumeric QWERTY keyboard. • Multi-touch touchpad (touch panel). • Numeric keypad optimized to operate with the CNC (keys for axes, feedrate, speed, etc). • Special functions with the Fagor key.



In the operating system, customize the keyboard arrangement as "English (United States)". See "8.7 Selecting the language and the keyboard distribution." on page 111.

HORIZONTAL KEYB 2.0 + TOUCHPAD.

8.

8.1 Specifications.

Type.	Description. HORIZONTAL KEYB 2.0 + TOUCHPAD
General.	<ul style="list-style-type: none"> • USB horizontal, alphanumeric QWERTY keyboard. • Multi-touch touchpad (touch panel). • Numeric keypad optimized to operate with the CNC (keys for axes, feedrate, speed, etc). • Special functions with the Fagor key. • Keyboard distribution; "English (United States)". • Dimensions (width x height x depth) <ul style="list-style-type: none"> - 420 x 175 x 34 mm. - 16.54" x 6.89" x 1.33". • Weight: 3,065 kg (6.75 lb)
Regulation.	<ul style="list-style-type: none"> • CE.
Ambient.	<ul style="list-style-type: none"> • Storage temperature: Between -40 and 70 °C (-40 and 158 °F). • Working temperature: Between 0 and 55 °C (32 and 131 °F). • Relative humidity: 90 % RH (non-condensing). • Vibrations: Vibration test according to IEC 60068-2-6 with a frequency step of 1 octave/minute (±10%) and a duration of 10 sweeps. Frequency of 5 Hz at 8.4 Hz (3.5 mm constant movement) and 8.4 Hz at 150 Hz (1 g of constant acceleration). • Degree of protection: IP65 (front panel).
Power supply.	<ul style="list-style-type: none"> • Power through the USB cable. • Maximum consumption: 0.5 W.
Connectivity.	<ul style="list-style-type: none"> • Connection to the central unit through USB-B 2.0 (rear).

FAGOR

FAGOR AUTOMATION

CNC 8070

(REF: 1709)

8.2 General diagram.



- Do not replace the cable supplied by Fagor.
- Do not connect any type of extension cord to the USB power cable.
- Connect the keyboard directly to the central unit; do not connect the keyboard to any type of hub.

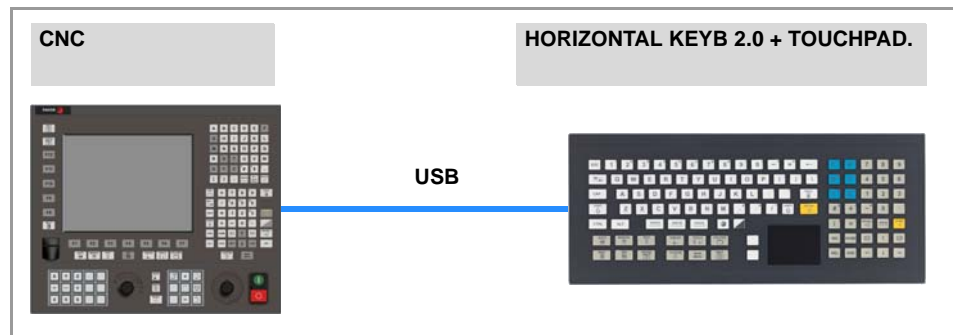

Connection.	Description.
USB	Communication with the CNC and voltage supply. Maximum length; 800 m (32.50 inches).

8.

HORIZONTAL KEYB 2.0 + TOUCHPAD.

8.3 Dimensions.

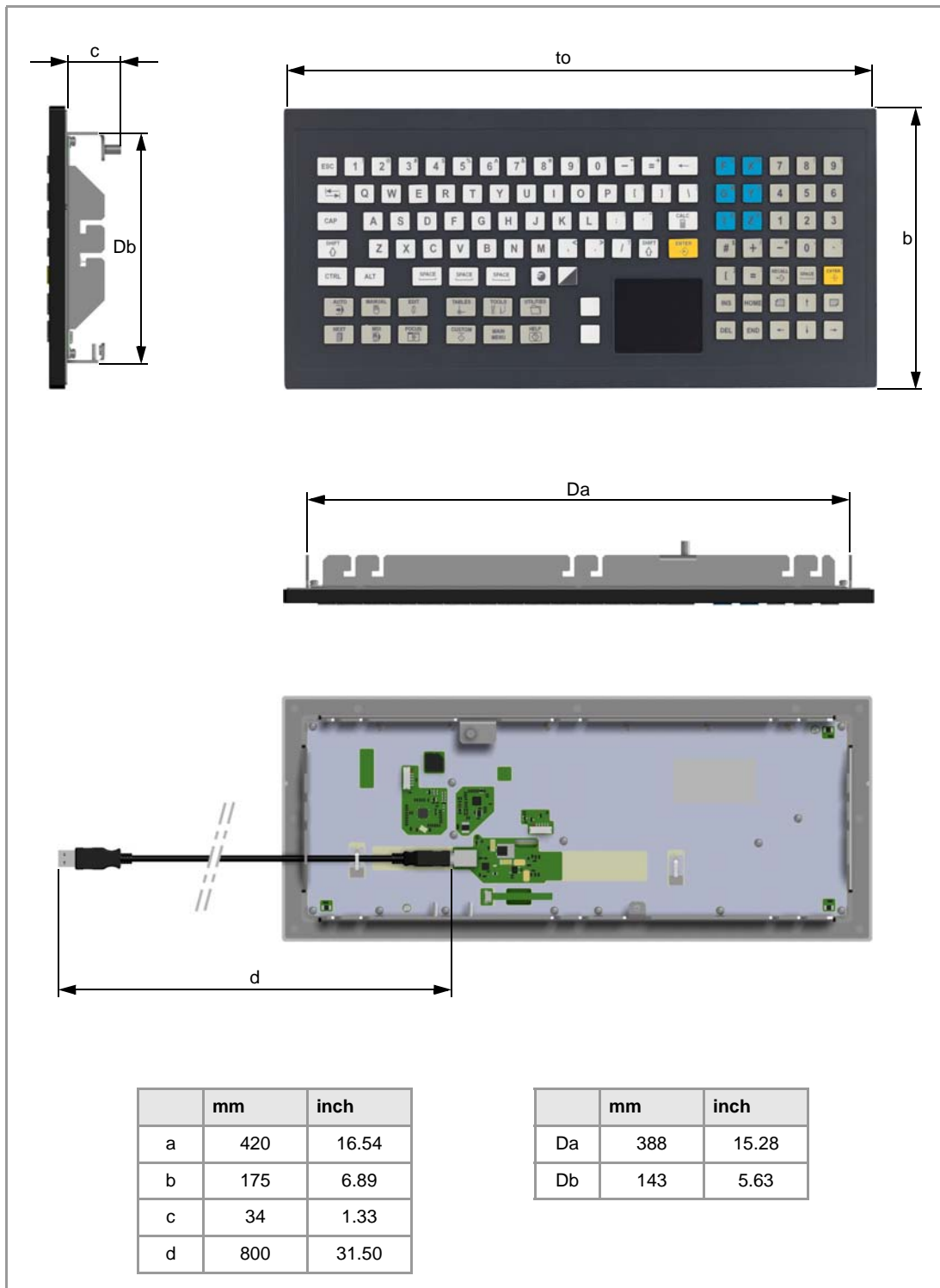

HORIZONTAL KEYB 2.0 + TOUCHPAD.



FAGOR AUTOMATION

CNC 8070

(REF: 1709)

8.4 Enclosure and mounting of the module.

8.4.1 Enclosure design.

The enclosure must meet the following requirements:

- The degree of protection of the enclosure must be IP54, according to standard IEC 60529.
- Keep the enclosure clean. If the enclosure has ventilation holes, anti-dust filters should be installed in all of them.
- The dissipation surface of the enclosure must be enough to evacuate (by convection) the heat generated inside.
- In the connector area, reserve a space that allows the cables to be connected, respecting their radius of curvature.
- Respect the minimum distances recommended between the enclosure walls and the hardware to let the air flow and improve heat dissipation.



To meet the previous requirements, Fagor recommends the following.

- The enclosure must not have any ventilation holes, because they could let dust or other substances in.
- To improve heat dissipation, install a fan inside the enclosure for air circulation.



Before building an enclosure with glass fiber or another poor heat dissipating material, contact Fagor Automation.

Dimensions of the cut off part and the enclosure.

General tolerance for W and H = ± 0.5 mm (0.02 inches).
Maximum radius of the corners = 5 mm (0.2 inches).

	mm	inch
W	392	15.43
H	147	5.79

	mm	inch
D (*)	74	2.91
e	1.5 - 4	0.06 - 0.16

(*) Minimum recommended distance.

8.4.2 Securing the module.

The module must be installed in a proper enclosure that may be located on the machine or on an external support. To insert the unit into the enclosure, it must have a big enough hole to allow to insert it easily, without obstacles and without forcing the unit. See "8.4.1 Enclosure design." on page 108.

The module is mounted from inside the enclosure. Once the unit has been inserted into the enclosure, secure it from the inside with the tension jacks. To properly secure it, use all the tension jacks on the back of the unit. Apply a tightening torque of 0.7 Nm.

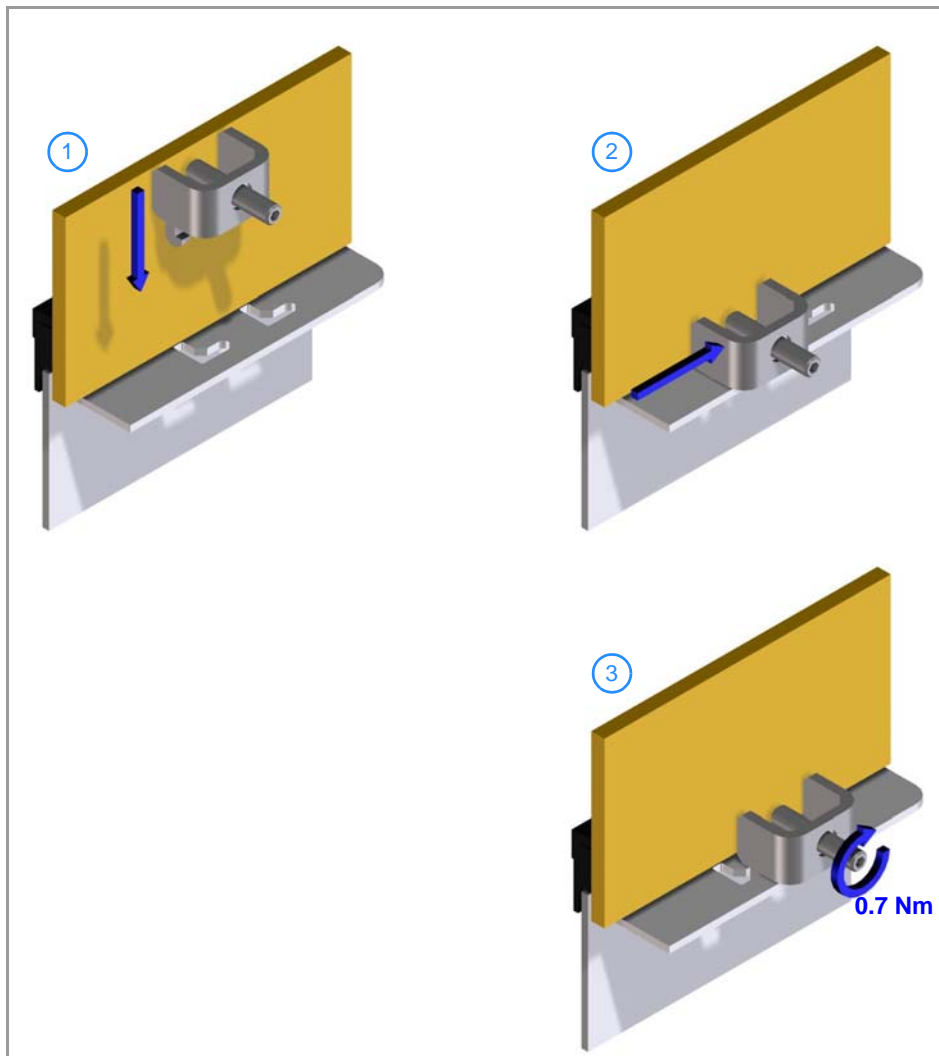

8.

HORIZONTAL KEYB 2.0 + TOUCHPAD.

FAGOR 

FAGOR AUTOMATION

CNC 8070

(REF: 1709)

8.5 Voltage supply for the module.

Power the module through the keyboard's USB cable.

Rear view.

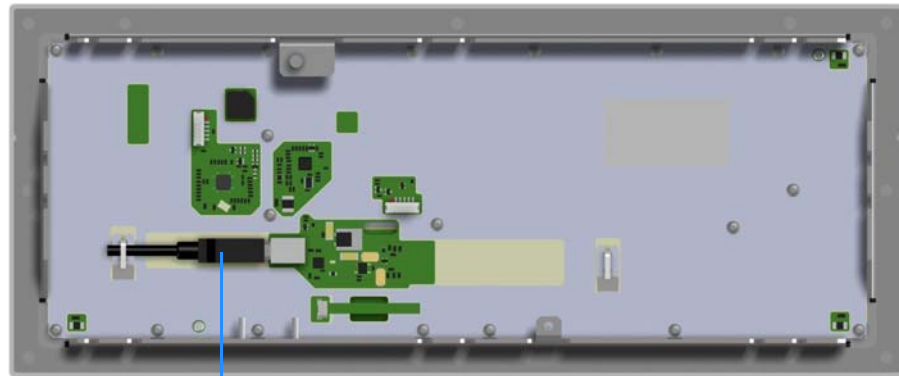

USB power cable.



- Do not replace the cable supplied by Fagor.
- Do not connect any type of extension cord to the USB power cable.
- Connect the keyboard directly to the central unit; do not connect the keyboard to any type of hub.

Cable characteristics.

Characteristic.	Description.
Type.	USB cable, type A-B. Shielded cable. 4-Wire cable in twisted pairs.
Characteristic impedance.	90 Ω \pm 15 %.
Length.	0.8 meters (0.03 inches).
Bending radius.	Fixed installation: 5 x d (d=7 mm). Flexible installation: 10 x d (d=7 mm).
Resistance to oils.	Meets the DIN EN 60811-2-1 standard

Consumption.

Maximum consumption: 0.5 W.

8.6 Connectors.

The connectors are in the rear.

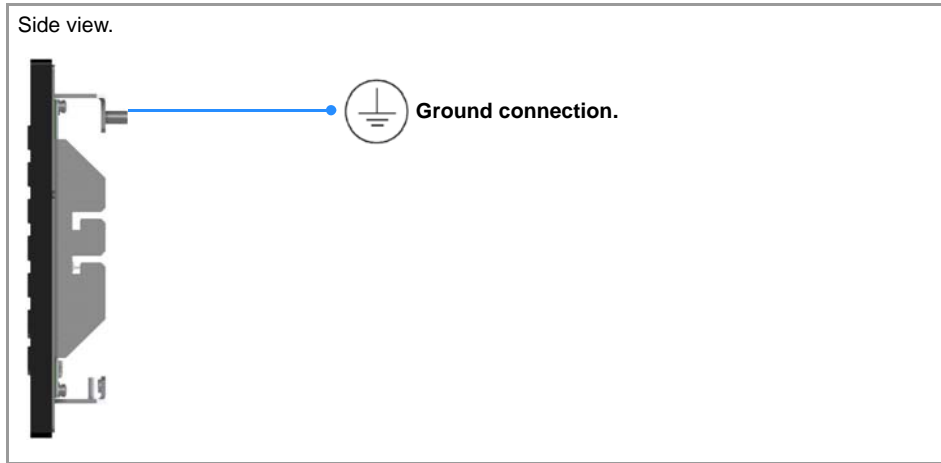

8.

HORIZONTAL KEYB 2.0 + TOUCHPAD.

8.7 Selecting the language and the keyboard distribution.

In the operating system, customize the input language and the keyboard distribution as "English (United States)". The keyboard distribution controls the characters that appear on screen when the keys are pressed. If the keyboard distribution is not assigned to this language, it is possible that the characters on screen will not match the characters of the keys.

In order to change the keyboard distribution, the desired input language and keyboard distribution must be added to Windows.

Adding an input language and a keyboard distribution.

- 1 Click on the Start menu > Control panel > Regional and language configuration. Depending on how Windows is configured, it may be necessary to first select "Clock, language and region".

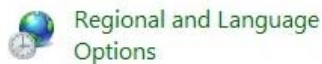

- 2 Click on the "Keyboards and languages" tab and then click on "Change keyboards".

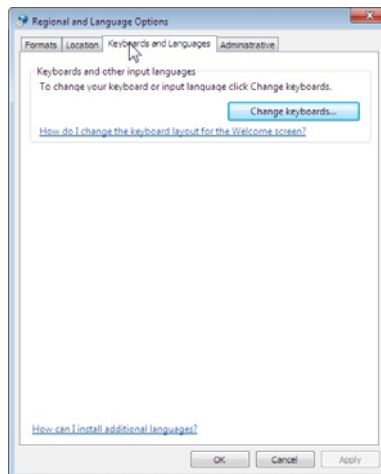

FAGOR AUTOMATION

CNC 8070

(REF: 1709)

- 3 In the "Installed services" section, click on the button "Add". Add the desired input language and the keyboard distribution (in this case, English (United States)). Click on "OK" to finish.

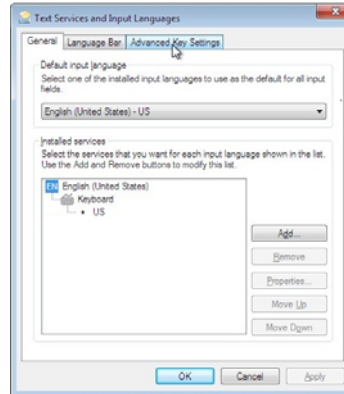

Changing the input language.



On the login screen, click on the language button (top left corner of the screen) and select the language "English (United States)".

Change the input language (only for the active window).



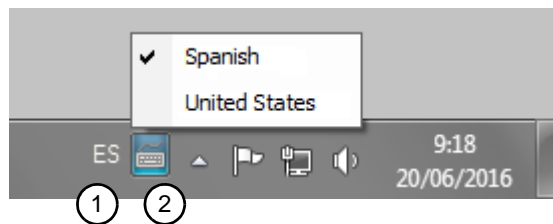





- 1 In the language bar, click on the button "Input language" and select the language "English (United States)".
- 2 Next, click on the button "Keyboard distribution" and select the distribution "United States".



8.

HORIZONTAL KEYB 2.0 + TOUCHPAD.

8.8 Using the Fagor logo key.

Keys.	Meaning.
 + [1] .. [0]	Keys [F1] to [F10].
 + [-]	Key [F11].
 + [=]	Key [F12].
 + [S]	Cancel or activate the keystroke sound.
 + [T]	Cancel or activate the touchpad (touch panel).
 + [C]	Change the function of the axis keys on the numeric keypad; write the name of axis1 to axis6 / always write X, Y, Z, A, B, C.
 + [D]	Minimize everything / Show the last active application.
 + [P]	Print screen; can be combined with [SHIFT] and with [ALT].
 + [E]	Open the Windows Explorer.

8.

HORIZONTAL KEYB 2.0 + TOUCHPAD.

8.9 Numeric keypad.

Numeric keypad optimized to operate with the CNC (keys for axes, feedrate, speed, etc). The second function of the keys is available with a long press of the key; the [SHIFT] key is not necessary.

The behavior of the three axis keys can be modified with the [FAGOR]+[C] keys.

Option 1.

The keys write the name of the first six axes of the channel.

Option 2.

The keys always write the characters X Y Z A B C.



FAGOR 

FAGOR AUTOMATION

CNC 8070

(REF: 1709)

8.10 Touchpad (touch screen).

8.

HORIZONTAL KEYB 2.0 + TOUCHPAD.

Left button.

Right button,



Primary button.

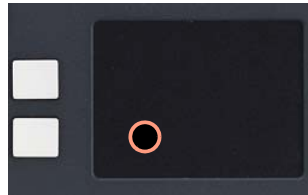

Tap lightly with one finger to simulate a mouse click.

Double click.

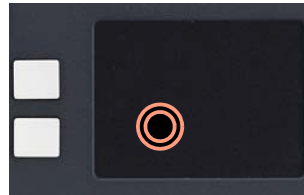

Tap lightly twice with one finger to simulate the double click of a mouse.

Secondary button.

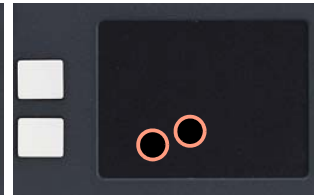

Tap lightly with two fingers to simulate the right click of a mouse.

Move the cursor.



Move a finger to move the cursor.

Move screen (pan).

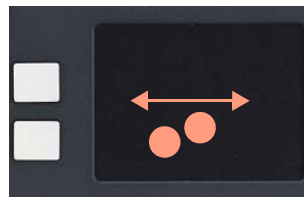

Move two fingers to the left and right to move horizontally (pan).

Move screen (scroll).



Move two fingers up and down to move vertically (scroll).

Zoom.



Pinch or separate two fingers to zoom in or out.

Turn the page.



Drag three fingers horizontally to move forward or back a page.

Minimize the window.



Drag three fingers downward to minimize the active window.

Start menu.



Drag three fingers upward to access the start menu.

The actions of touching with one or two fingers work in reverse if the mouse is configured for left-handed people.

9 OP-PANEL / OP-PANEL+SPDL RATE.



The machine manufacturer must comply with the EN 60204-1 (IEC-204-1) regulation regarding electrical shocks in case of defective input/output pins with external power supply when not plugging the connector before turning the power supply on.

Module.	Description.
OP-PANEL	CAN operator panel 420 mm (16.54") with spindle override. Possibility to connect up to three electronic handwheels.
OP-PANEL+SPDL RATE	CAN Operator panel 420 mm (16.54") with spindle override switch. Possibility to connect up to three electronic handwheels.

OP-PANEL

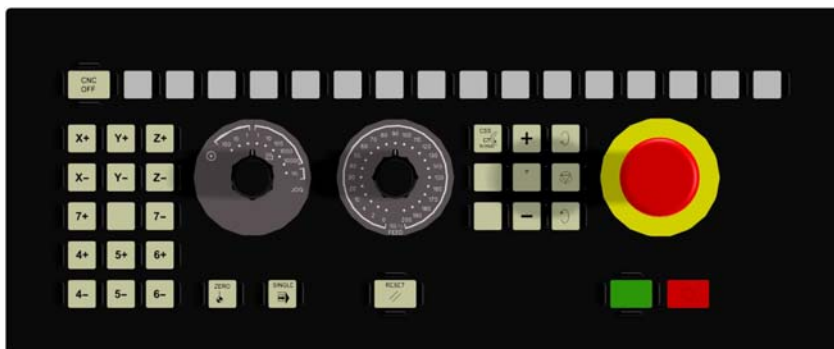

OP-PANEL+SPDL RATE

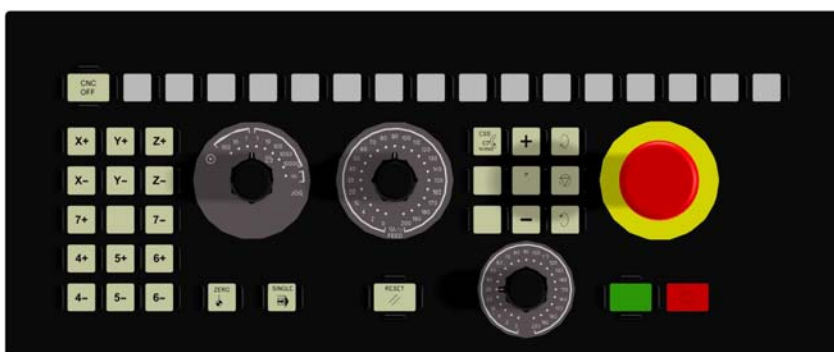

9.1 Specifications.

Type.	Description.
General.	<ul style="list-style-type: none"> Jog switch (0 - 200 %). 16 configurable user keys. 15 configurable jog keys. Speed override key (OP-PANEL). Speed override switch (OP-PANEL+SPDL RATE). CNC power-down key. Dimensions (width x height x depth) <ul style="list-style-type: none"> - 420 x 175 x 54.5 mm. - 16.54" x 6.89" x 2.15".
Safety.	<ul style="list-style-type: none"> CE
Ambient.	<ul style="list-style-type: none"> Degree of protection: IP65 (front panel).
Power supply.	<ul style="list-style-type: none"> 24 V DC universal power supply, via Phoenix connector.
Connectivity.	<ul style="list-style-type: none"> Connecting the central unit via CAN (CANopen/CANfagor). Three handwheels with A and B signals (5 V DC TTL).

9.

OP-PANEL / OP-PANEL+SPDL RATE.

FAGOR

FAGOR AUTOMATION

CNC 8070

(REF: 1709)

9.2 General diagram.

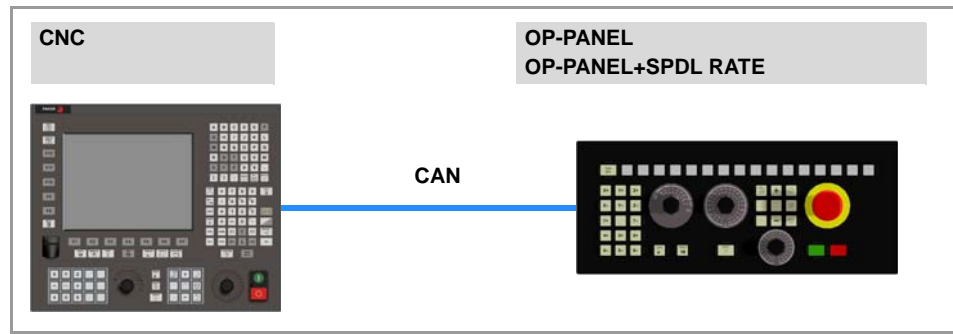

Connection.	Description.
CAN	Communication with CNC. Maximum length: 500 m (1640 ft) for the CANopen bus.

OP-PANEL / OP-PANEL+SPDL RATE.

9.3 Dimensions.

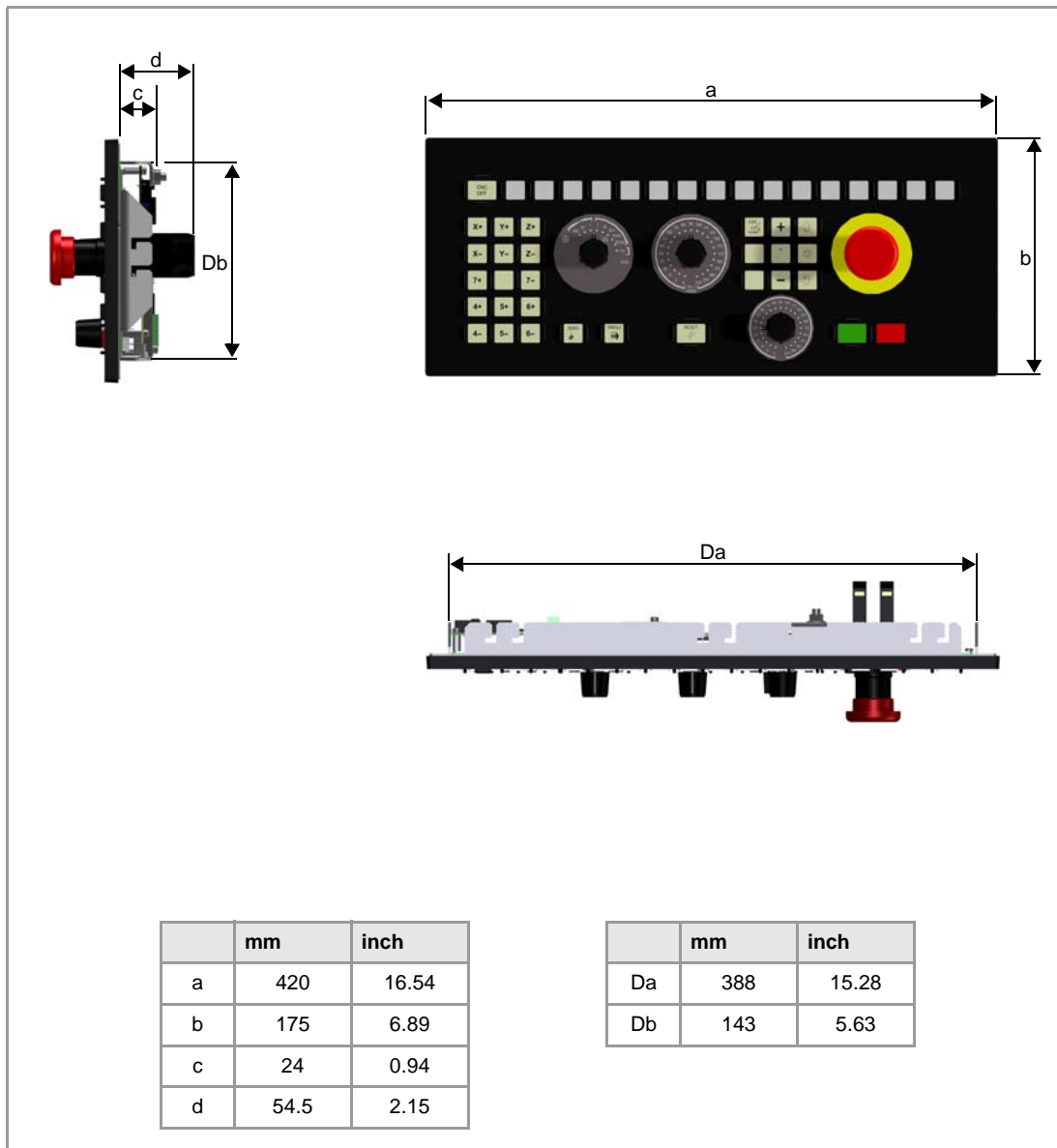

9.

OP-PANEL / OP-PANEL+SPDL RATE.

9.4 Enclosure and mounting of the module.

9.4.1 Enclosure design.

The enclosure must meet the following requirements:

- Keep the enclosure clean. If the enclosure has ventilation holes, anti-dust filters should be installed in all of them.
- Reserve some room for the laying out cables in the connector area. This space must allow for the connection of cables, while accounting for their bending radius.
- The cabinet must consider the minimum recommended distances between the enclosure walls and the hardware to let the air flow and improve heat dissipation.



To meet the previous requirements, Fagor recommends the following.

- The enclosure must not have any ventilation holes, because they could let dust or other substances in.
- To improve heat dissipation, install a fan inside the enclosure for air circulation.



Before building an enclosure with glass fiber or another poor heat dissipating material, contact Fagor Automation.

Dimensions of the cut off part and the enclosure.

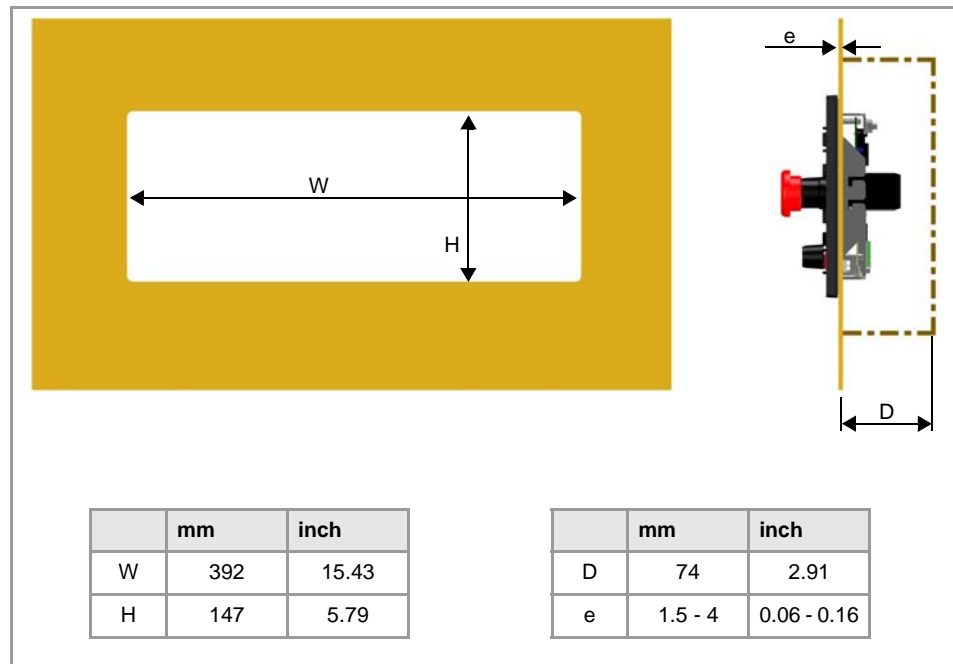

9.4.2 Securing the module.

The module must be installed in a proper enclosure that may be located on the machine or on an external support. To insert the unit into the enclosure, it must have a big enough hole to allow to insert it easily, without obstacles and without forcing the unit. See "9.4.1 Enclosure design." on page 118.

The module is mounted from inside the enclosure. Once the unit has been inserted into the enclosure, secure it from the inside with the tension jacks. To properly secure it, use all the tension jacks on the back of the unit. Apply a tightening torque of 0.7 Nm.

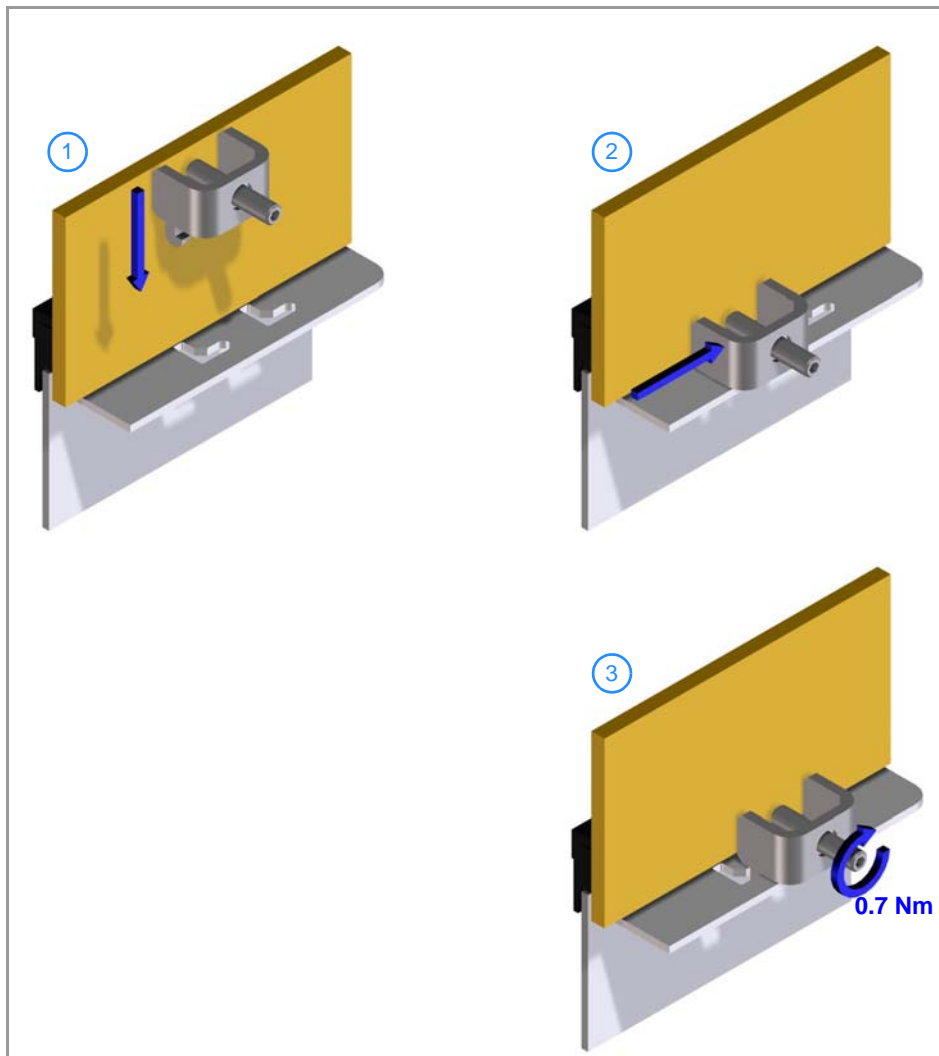

9.

OP-PANEL / OP-PANEL+SPDL RATE.

FAGOR 

FAGOR AUTOMATION

CNC 8070

(REF: 1709)

9.5 Power supply for the module.

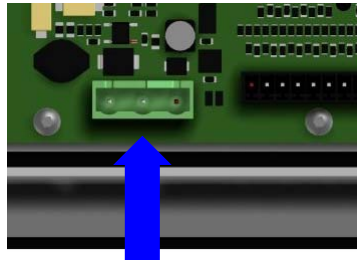

24 V DC

24 V DC universal power supply, via Phoenix connector. See ["24 V DC voltage supply."](#) on page 122.

Connector pinout.



Plug-in part 3-pole Phoenix-type combicon connector (7.62 mm pitch).
Rated current; 12 A.

Pin	Signal.	Function.
1		Chassis.
2	11	0 V reference signal.
3	+24 V	Power supply.

OP-PANEL / OP-PANEL+SPDL RATE.

9.6 Hardware functionalities.

9.6.1 Ground connection.



It is up to the system integrator to meet all the requirements of local and national electrical codes as well as all the regulations applicable regarding the grounding of the whole unit.

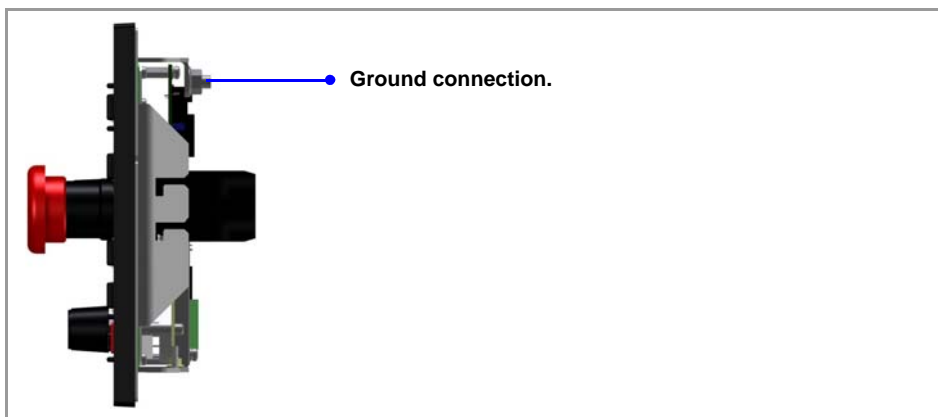

9.6.2 Rear connectors.

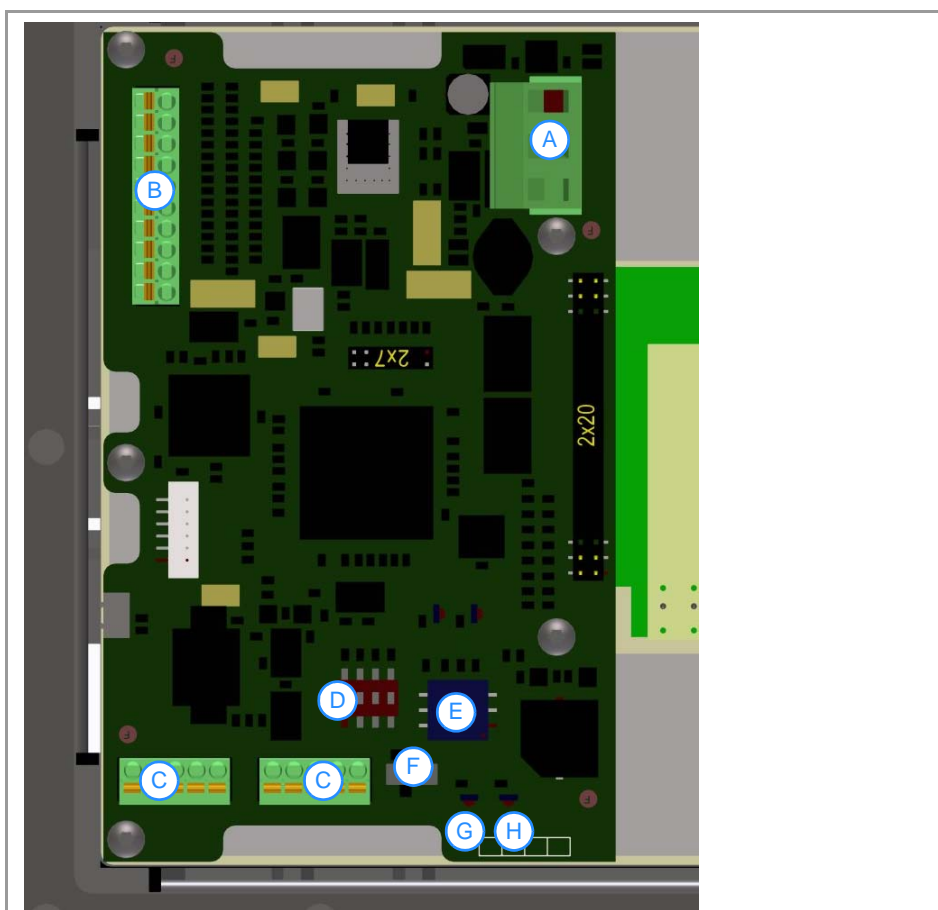

- (A) 24 V DC voltage supply.
- (B) Handwheels.
- (C) CAN bus.
- (D) Bus switch and transmission frequency (CANfagor).
- (E) Address (node) of the element.
- (F) Line terminating resistor.
- (G) ERR led, transmission status indicator.
- (H) RUN led, module status indicator.

9.

OP-PANEL / OP-PANEL+SPDL RATE.

FAGOR

FAGOR AUTOMATION

CNC 8070

(REF: 1709)

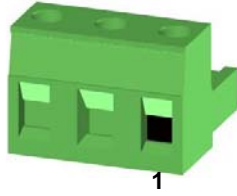
24 V DC voltage supply.

Plug-in part 3-pole Phoenix-type combicon connector (7.62 mm pitch). Rated current; 12 A.

Pin	Signal.	Function.
1		Chassis.
2	11	0 V reference signal.
3	+24 V	Power supply.

Connector data.	
Number of poles.	3.
Pitch.	7.62 mm.
Connection technique.	Screw connection.
Minimum/maximum tightening torque.	0.5 / 0.6 Nm.
Minimum/maximum section.	0.2 / 2.5 mm ² .
Minimum/maximum AWG section.	24 / 12.
Rated current I _n .	12 A.

Cable data.	
Length to be stripped.	7 mm.

See "[9.5 Power supply for the module.](#)" on page 120.

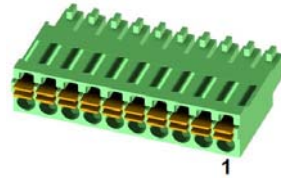
Handwheel connection.

Plug-in part 10-pole Phoenix-contact miniconbicon connector (3.5 mm pitch). Rated current; 8 A.

Pin.	Signal.	Function.
1	+5 V	5 V DC voltage supply.
2	---	---
3	---	---
4	MPG3-B	B signal of the third handwheel.
5	MPG3-A	A signal of the third handwheel.
6	MPG2-B	B signal of the second handwheel.
7	MPG2-A	A signal of the second handwheel.
8	MPG1-B	B signal of the first handwheel.
9	MPG1-A	A signal of the first handwheel.
10	11	Power supply.

Connector data.	
Number of poles.	10.
Pitch.	3.5 mm.
Connection technique.	Spring connection.
Minimum/maximum section.	0.2 / 1.5 mm ² .
Minimum/maximum AWG section.	24 / 16.
Rated current I _n .	8 A.

Cable data.	
Length to be stripped.	7 mm.



Cable shields must be connected to the ground plate. See "[9.7 Handwheel connection.](#)" on page 125.

-B28A / B28B- CAN bus.

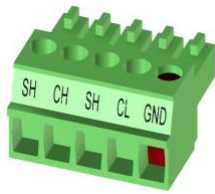

Plug-in part 5-pole Phoenix-contact minicombin connector (3.5 mm pitch). Rated current; 8 A.

Pin.	Signal.	Function.
1	11	Ground / 0 V.
2	CL	(LOW) bus signal.
3	SH	CAN shield.
4	CH	(HIGH) bus signal.
5	SH	CAN shield.

Connector data.	
Number of poles.	5.
Pitch.	3.5 mm.
Connection technique.	Screw connection.
Minimum/maximum tightening torque.	0.22 / 0.25 Nm.
Minimum/maximum section.	0.14 / 1.5 mm ² .
Minimum/maximum AWG section.	28 / 16.
Rated current I _n .	8 A.

Cable data.	
Length to be stripped.	7 mm.

9.

OP-PANEL / OP-PANEL+SPDL RATE.

CAN bus. Bus switch; CANfagor/CANopen.

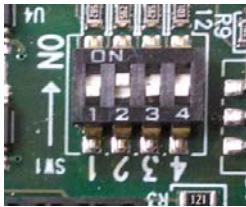

Switch 1 of the DIP switch selects the type of CAN bus to be used, this being either CANfagor or CANOpen.

DS -1-	Type of CAN bus.
off	The CANfagor bus has been selected.
on	The CANopen bus has been selected.

CAN bus. Transmission frequency (CANopen).

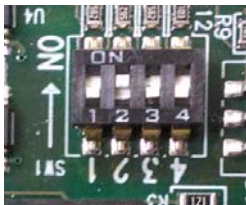

With the protocol CANopen, switches 2 and 3 of the DIP switch allow for the transmission frequency to be selected. All the bus nodes must work under the same frequency. The transmission frequency depends on the total length of the bus. Using the following illustrative values; assigning other values may cause communication errors due to signal distortion.

DS -2-	DS-3-	Frequency.	Length of the CAN bus.
on	on	1000 kHz	Up to 20 meters.
off	on	800 kHz	From 20 to 40 meters.
on	off	500 kHz	From 40 to 100 meters.
off	off	250 kHz	From 100 to 500 meters.

In order for any change of frequency to take place, the corresponding module must be reset; however, we recommend to change the speed while the modules and the CNC are turned off.

CAN bus. Address (node) of the element.

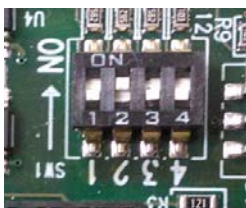

The 4 switch of the DIP switch allows for up to 32 positions or elements to be integrated in the CAN bus.

DS -4-	Address (node) of the element.
off	Positions 0-15 within the bus.
on	Positions 16-31 within the bus.



FAGOR AUTOMATION

CNC 8070

(REF: 1709)

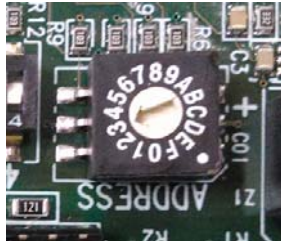
CAN bus. Address (node) of the element.

Each one of the elements (nodes) integrated into the CAN bus is identified by the 16-position rotary switch (0-15) "Address" (also referred to as "Node_Select"). With the ADD MSB switch, the positions or elements integrated in the CAN bus may be expanded up to 32. The "Address" switch also sets the priority of the node within the bus; the lower the number the higher the priority.

The CNC must always occupy position "0" and the rest of the elements of the bus will occupy consecutive positions starting with 1. It is recommended to place the remote modules after the CNC and for the keyboard and the jog panel to be the last nodes of the bus.

In order for any change at the "Address" switch to be assumed, the CNC must be restarted and the corresponding drive must be reset, however, we recommend to change the address while the modules and the CNC are off.

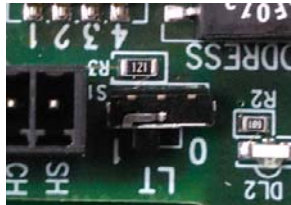
CAN bus. Line terminating resistor.

The line terminating resistor identifies which are the elements that occupy the ends of the CAN bus; i.e. the first and last physical element in the connection. The terminating elements must have the resistor activated (position 1) but not the rest of the elements (position 0).

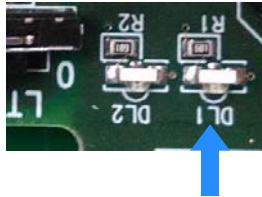
RUN Led. Module status.

Green Led. The meaning depends on the blinking frequency.

Blinking rate.	Description.
Intermittent.	Module in PRE-OPERATIONAL state.
Single blinking.	Module in STOPPED state.
On.	Module in OPERATIONAL state.

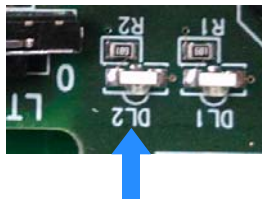
Led ERR. Transmission status.

Red LED. The meaning depends on the blinking frequency.

Blinking rate.	Description.
Off.	The module is ready to run.
Intermittent.	Module configuration stage.
Single blinking.	Poor transmission. At least one of the error counters of the CAN controller has reached the alarm level.
Double blinking.	There is no communication with the cpu.
On	Error. The CAN controller is in "Bus Off" state.

9.7 Handwheel connection.

The keyboard admits the connection of up to 3 handwheels (MPG1, MPG2 and MPG3) with A and B signals (5 V DC TTL). If the handwheel has an axis selector button, the button signal may be connected to a digital input and may be managed from the PLC using the NEXTMPGAXIS mark.

Connector pinout.

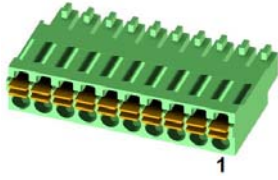

Plug-in part 10-pole Phoenix-contact minicombicon connector (3.5 mm pitch). Rated current; 8 A.

Pin.	Signal.	Function.
1	+5 V	5 V DC voltage supply.
2	---	---
3	---	---
4	MPG3-B	B signal of the third handwheel.
5	MPG3-A	A signal of the third handwheel.
6	MPG2-B	B signal of the second handwheel.
7	MPG2-A	A signal of the second handwheel.
8	MPG1-B	B signal of the first handwheel.
9	MPG1-A	A signal of the first handwheel.
10	11	Power supply.

Cable characteristics.

The cable being used must have overall shield. The unshielded portion of the wires of an unshielded cable cannot be longer than 75 mm.

Connection.

We recommend to run the handwheel cable as far away as possible from the power cables of the machine.



Always connect the shield of the cable to the ground plate using a metallic clamp.

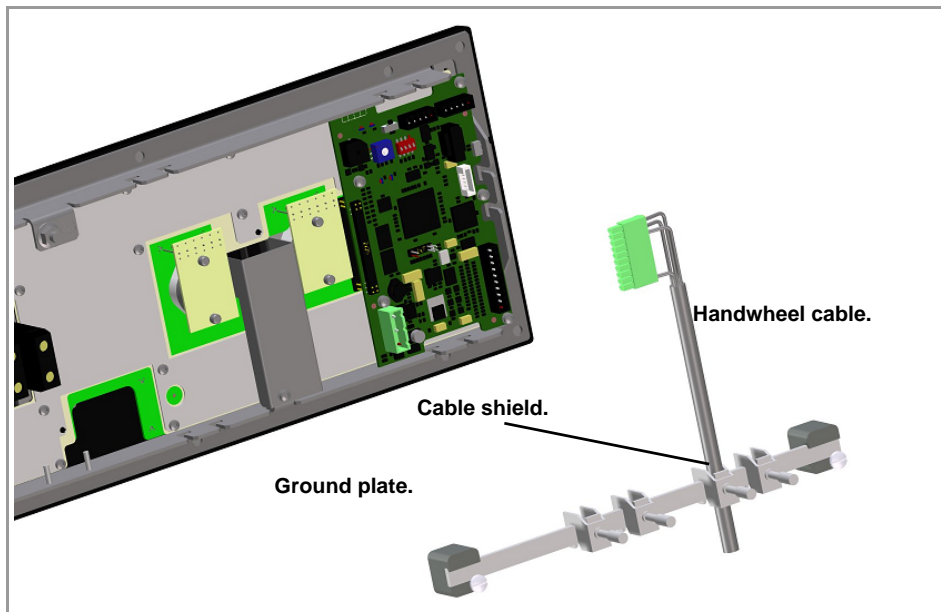

9.

OP-PANEL / OP-PANEL+SPDL RATE.



CNC 8070

(REF: 1709)

10 MOUSE MODULE.

Módulo.	Descripción.
MOUSE	Ratón con conector PS-2



10.

MOUSE MODULE:

10.1 Especificaciones.

Tipo.	Descripción. (OP PANEL 329)
General.	<ul style="list-style-type: none"> • Dimensions (ancho x alto x fondo). <ul style="list-style-type: none"> - 126 x 70 x 10.2 mm. - 4.96" x 2.76" x 0.40".
Regulation.	<ul style="list-style-type: none"> • CE
Power supply.	<ul style="list-style-type: none"> • Power through the PS-2 cable.
Connectivity.	<ul style="list-style-type: none"> • Connection to the central unit through PS-2 connector.

10.2 Dimensions.

10.

MOUSE MODULE.

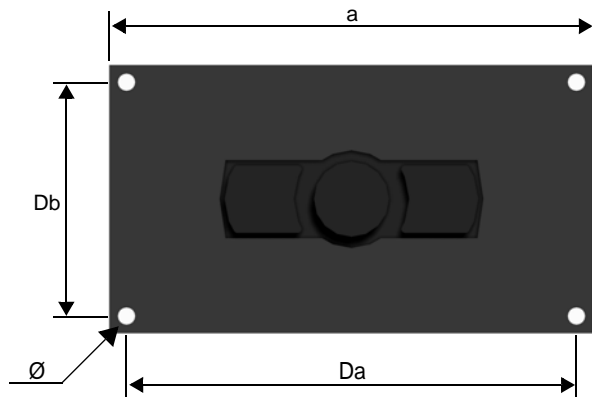

	mm	inch
a	126	4.96
b	70	2.76
c	10.2	0.40

	mm	inch
Da	117	4.61
Db	61	2.40
Ø	4.5	0.18

11 EMERGENCY BATTERY.

The emergency battery ensures the operation of the central unit against power failures and, if necessary, allows the CNC to execute the automatic shut-down sequence due to a power failure.

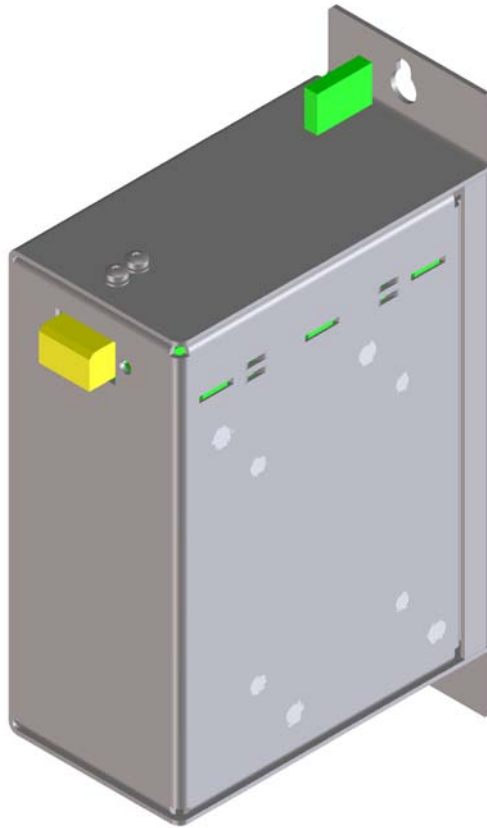

General characteristics.

Charge time.	35 hours.
Autonomy.	About 20 minutes with the battery completely charged.
Work temperature.	Between 5 °C (41 °F) and 40 °C (104 °F).



Read the connection instructions carefully before connecting the battery. Connect the battery only to the central unit; DO NOT try to power any other device with the battery. Recharge the battery only through the central unit; DO NOT try to recharge it with any other device. Do not throw the battery into the fire. Do not short-circuit the pins of the battery.

11.

EMERGENCY BATTERY.

FAGOR 

FAGOR AUTOMATION

CNC 8070

(REF: 1709)

11.1 Battery dimensions.

11.

EMERGENCY BATTERY.

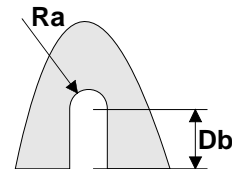
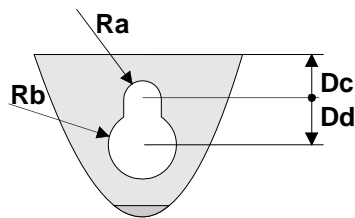
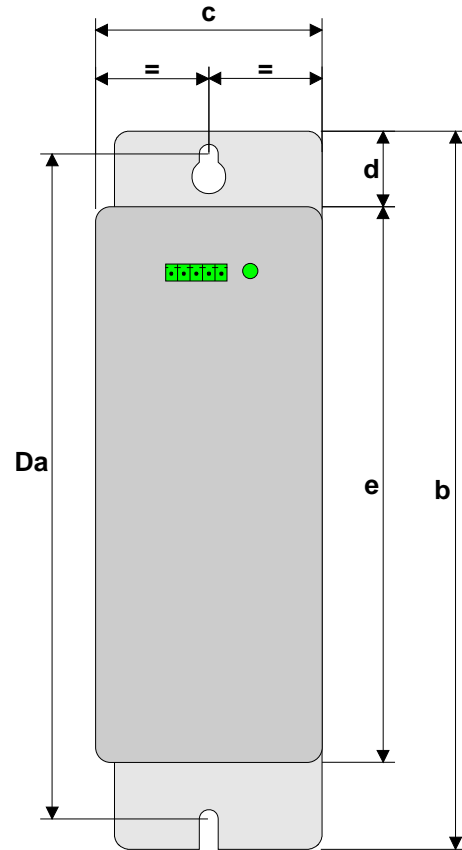
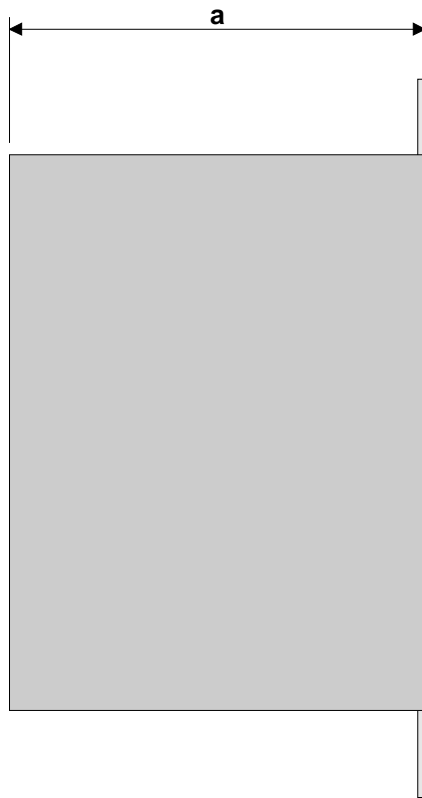

	mm	inch
a	110	4,33
b	189,3	7,45
c	60	2,36
d	21	0,83
e	147,1	5,79

	mm	inch
D_a	175	6,89
D_b	8	0,31
D_c	6	0,24
D_d	6	0,24
R_a	R 2,50	R 0,10
R_b	R 4,50	R 0,18

11.2 Connectors and connection.

Connector. Powering the central unit and charging the battery.

5-pin male Phoenix minicombicon contact (3.5 mm pitch).

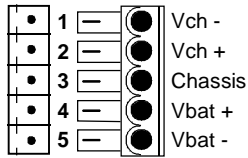

Signal	Function
Vbat - Vbat +	Central unit powered by the battery.
Chassis	Shield.
Vch - Vch +	Recharging the battery through the central unit.

The battery has a single connector to charge it and to power the CNC when necessary.

Status indicator LED.

The LED located next to the connector indicates the status of the battery. The LED blinks while the battery is being charged and it stays on when the battery is charged.

Connection to the central unit.

Connect all the pins of the battery to the central unit. The battery is charged from the central unit; DO NOT use any other device to recharge it.

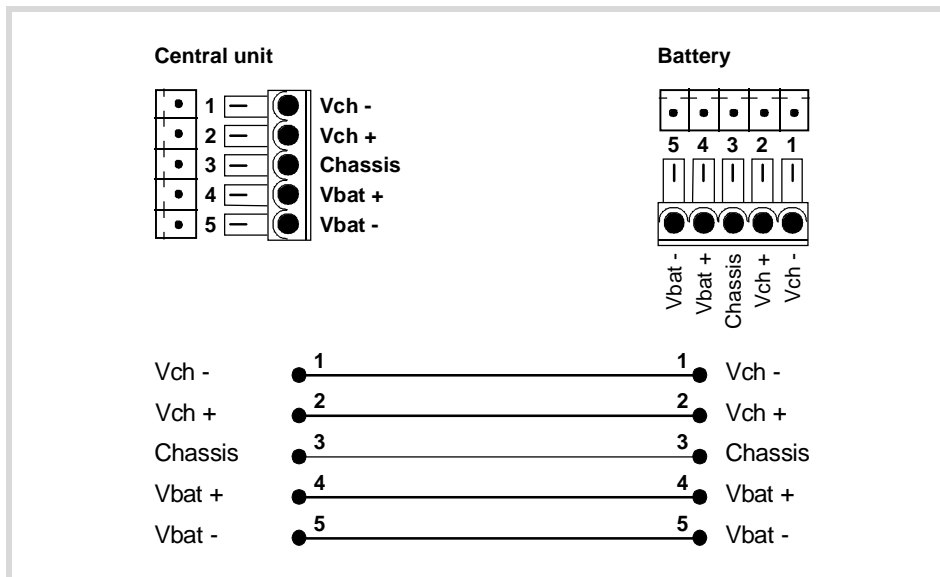

11.

EMERGENCY BATTERY.

11.3 Operation of the emergency battery.

Central unit powered by the battery.

The battery only powers the central unit when a failure occurs at the power supply (a drop of the 24 V). The Fagor battery provides an autonomy of about 20 minutes when it is fully charged.

Response of the CNC with battery to mains failures

When a power supply failure occurs (drop at the 24 V) and there is a battery connected to the central unit, the latter responds as follows:

- If the supply is interrupted for less than 2 seconds.

The CNC shows the corresponding warning and the system recovers fine. Errors may occur at the CAN bus due to the lack of 24V at the remote modules.

- If the supply is interrupted for more than 2 seconds.

After the 2 seconds, the CNC shows the corresponding error and it initiates the automatic shut-down sequence. First of all, the CNC stops any process in progress (program in execution, tool change, etc.) and closes the CNC application. Then, the CCN shuts the whole system down and, finally, deactivates the battery.

Recharging the battery.

The battery is charged from the central unit; DO NOT use any other device to recharge it. The LED next to the connector blinks while the battery is being charged and it stays on when the battery is charged. The charging process takes about 35 hours.

11.**EMERGENCY BATTERY.**

FAGOR AUTOMATION

CNC 8070

(REF: 1709)

12 BUS CAN (CANFAGOR/CANOPEN PROTOCOLS).

CANfagor and CANopen are two network communication protocols based on the CAN bus system for connecting the CNC with remote modules and keyboards. The CAN connection supports up to 32 devices (nodes), including the central unit; more one than keyboard and several groups of remote modules are possible.

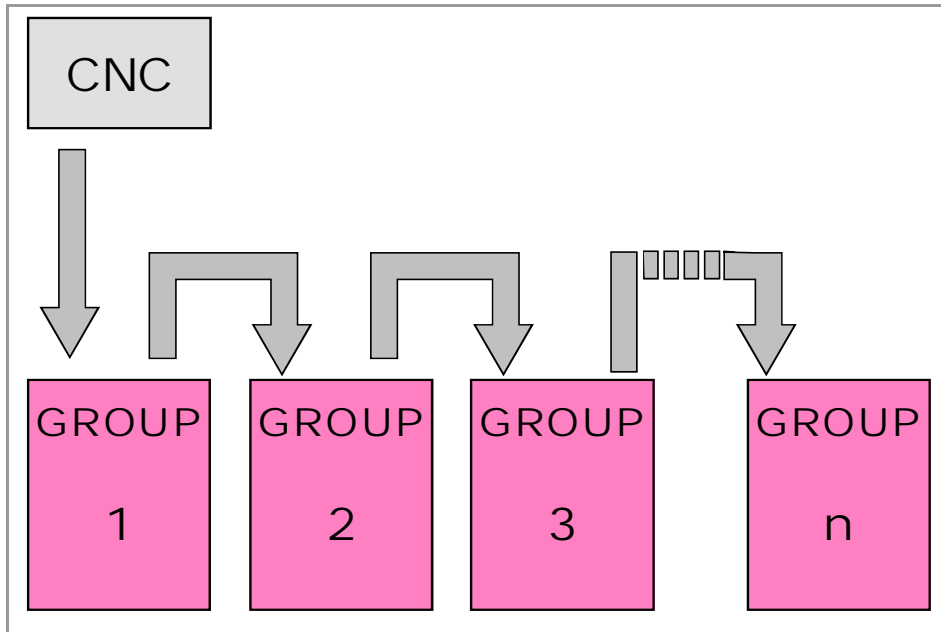

12.

BUS CAN (CANFAGOR/CANOPEN PROTOCOLS).

CAN connector.

5-pin male Phoenix minicombicon contact (3.5 mm pitch).

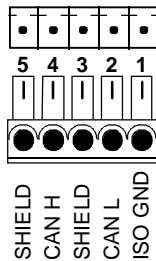

Pin.	Signal.	Function.
1	ISO GND	Ground / 0 V.
2	CAN L	(LOW) bus signal.
3	SHIELD	CAN shield.
4	CAN H	(HIGH) bus signal.
5	SHIELD	CAN shield.

The cable shield must be connected to the connector at both ends. The connector has two shield pins. Both pins are equivalent and the CAN shield may be connected to either one.

CAN cable characteristics.

Use a specific CAN cable. The ends of all the wires and the shield must be protected by the corresponding terminal (pin). Also use the terminals (pins) to secure the cable to the connector.

General characteristics.	
Type.	Shielded. Twisted pair (1 x 2 x 0.22 mm ²).
Flexibility.	Extremely flexible. Minimum bending radius, static = 50 mm and dynamic = 95 mm.
Cover.	PUR
Impedance.	Cat.5 (100Ω - 120Ω)

FAGOR 

FAGOR AUTOMATION

CNC 8070

(REF: 1709)

Module interconnection.

Respect the cable's minimum bending radius when connecting it. They must be connected in series; on elements having two CAN connectors, either one may be used. Once the elements have been connected, define their logic order in the bus and the transmission speed.

RIOR, RIO5 y RIO70 series remote modules.

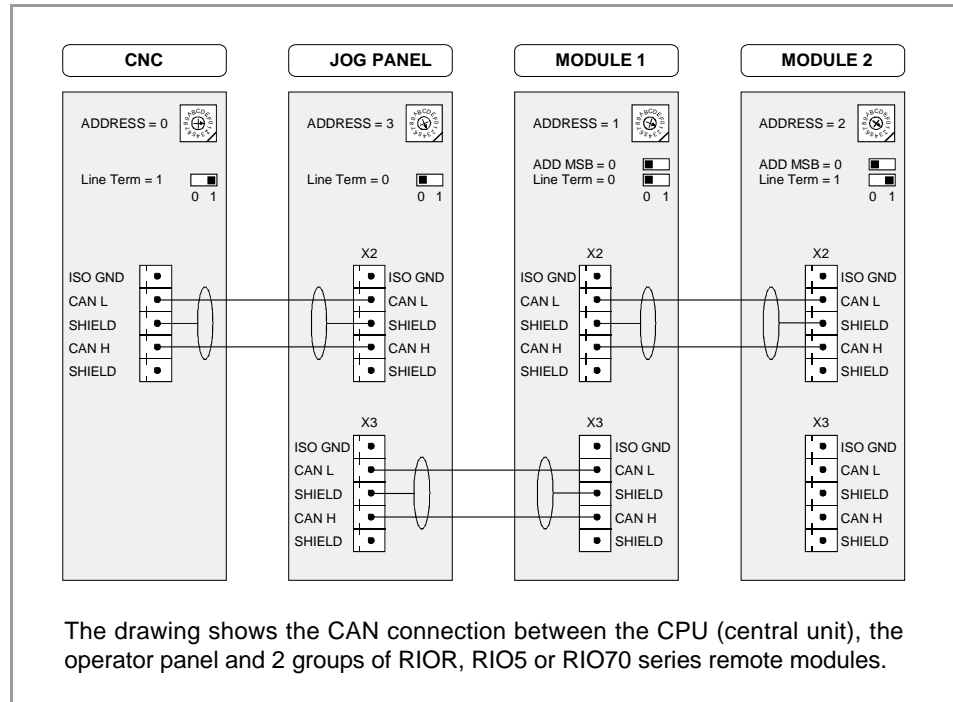

RIOW series remote modules.

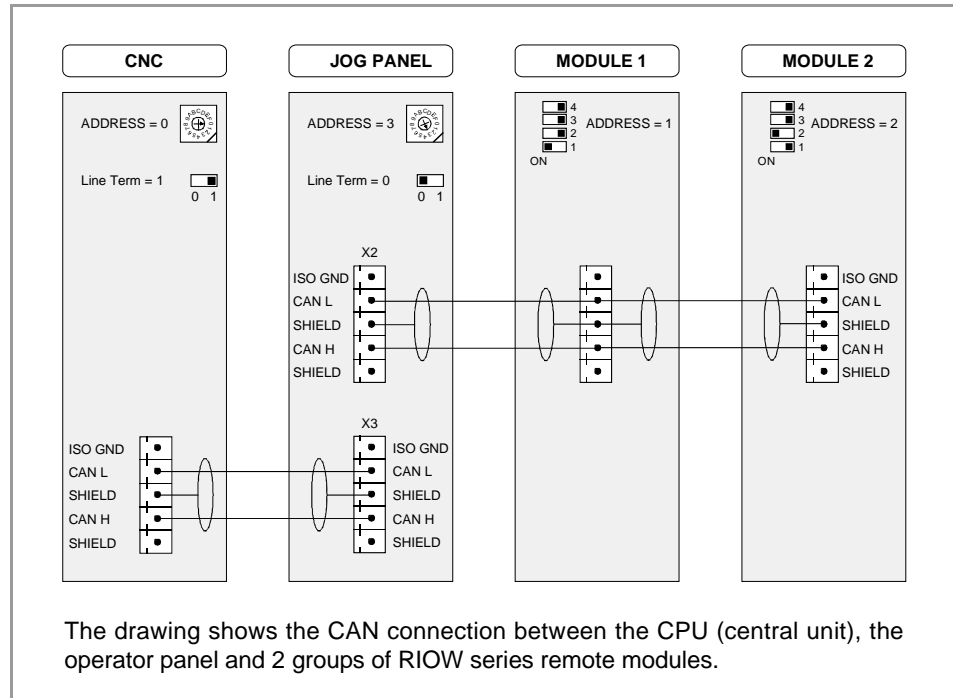

12.

BUS CAN (CANFAGOR/CANOPEN PROTOCOLS).



CNC 8070

(REF: 1709)

12.1 Identification of the modules at the bus.

Each one of the elements integrated into the CAN bus is identified by its address or node number. The CNC must always occupy position "0" and the rest of the elements of the bus will occupy consecutive positions starting with 1.

The node address or number also sets the priority of the group within the bus; the lower the number the higher the priority. We recommend to set the priority of the groups as follows (from highest to lowest).

- The groups that have the feedback inputs.
- The groups that have analog inputs and outputs.
- The groups that have digital inputs and outputs.
- The keyboard and jog panel

12.

BUS CAN (CANFAGOR/CANOPEN PROTOCOLS).

Configuring the address (node number). Operator panel and RIOR, RIO5 and RIO70 series remote modules.

-ADDRESS- selector. Address (node) of the element within the bus.



Each one of the elements integrated into the CAN bus is identified by the 16-position rotary switch (0-15) "Address" (also referred to as "Node_Select"). With the ADD MSB" switch, the positions or elements integrated in the CAN bus may be expanded up to 32.

In order for any change at the "Address" switch to be assumed, the CNC must be restarted and the corresponding drive must be reset, however, we recommend to change the address while the modules and the CNC are off.

The "Address" switch also sets the priority of the group within the bus; the lower the number the higher the priority. We recommend the keyboard and jog panel to be the last node of the bus.

-ADD MSB- selector Address (node) of the element within the bus.

With the -4- switch (ADD MSB), the positions or elements integrated in the CAN bus may be expanded up to 32. Positions 0-15 are selected with ADD MSB=0 and positions 16-31 with ADD MSB=1.

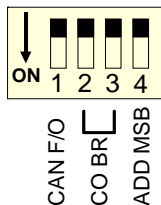

·CAN F/O·	Address (node) of the element.
OFF	Positions 0-15 within the bus.
ON	Positions 16-31 within the bus.

ADDRESS = 2

ADDRESS = 2

ADD MSB = 0

ADDRESS = 18

ADDRESS = 2

ADD MSB = 1

ADDRESS	0	1	2	3	...	13	14	15
ADD MSB =0	0	1	2	3	...	13	14	15
ADD MSB =1	16	17	18	19	...	29	30	31



FAGOR AUTOMATION

CNC 8070

(REF: 1709)

Configuring the address (node number). RIOW series remote modules.

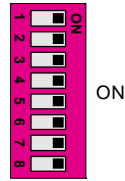

The dipswitch may be used to select the address of the node and the transmission speed.

The address (node number) of the group is selected while the module is off. Select the speed by putting the corresponding dipswitches in the ·on· position. The binary meaning of each dipswitch increases according to its number; dipswitch ·1· for address 1, dipswitch ·3· for address 4 and so on.



Identification of the first and last elements of the bus. Line terminating resistor.

In the CAN bus, it is necessary to use a line terminating resistor to identify which are the elements that occupy the ends of the bus; i.e. the first and last physical element in the connection. For the central unit, the terminating resistor is factory installed because the CNC is always at one end of the bus.

Operator panel and RIOR, RIO5 and RIO70 series remote modules. ·LT· selector.



The ·LT· switch identifies which are the elements that occupy the ends of the CAN bus; i.e. the first and last physical element in the connection.

The switch position of the terminating elements must be "1" and that of the rest of the elements "0". The central unit must always be at one end of the line even when not having this switch. The other end of the line will be the last physical device of the bus.

RIOW series remote modules.

The RIOW series modules do not have a factory-installed line terminating resistor. The RIOW module mounted at the end of the bus must have a 120 Ω line terminating resistor between pins CAN_H and CAN_L to avoid signal deflections (rebounds).

12.

BUS CAN (CANFAGOR/CANOPEN PROTOCOLS).

12.2 Type of CAN bus and baudrate.

Bus type selector: CANfagor / CANopen.

The CNC has two types CAN bus: CANfagor and CANopen. There are specific remote modules for each type of bus; at the CNC and at the operator panels, the type of active CAN bus must be selected.

Bus type selection at the operator panels.

Switch ·1· (CAN F/O) selects the type of CAN bus to be used, i.e. CANfagor or CANopen.

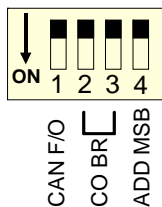

·CAN F/O·	Type of CAN bus.
OFF	The CANfagor bus has been selected.
ON	The CANopen bus has been selected.

Bus type selection at the CNC.

At the CNC, the type of CAN bus is selected by means of the machine parameters (parameter CANMODE),

12.

BUS CAN (CANFAGOR/CANOPEN PROTOCOLS).

FAGOR 

FAGOR AUTOMATION

CNC 8070

(REF: 1709)

12.3 Selecting the speed for the CANopen bus.

When using the CANopen protocol, the transmission speed at the bus is defined in each node and they all must run at the same speed. The transmission speed depends on the total length of the bus. Using the following illustrative values; assigning other values may cause communication errors due to signal distortion.

Speed	Length of the CAN bus.
1000 kHz	Up to 20 meters.
800 kHz	From 20 to 40 meters.
500 kHz	From 40 to 100 meters.
250 kHz	From 100 to 500 meters. The speed of 250 kHz is only available to communicate with the keyboards and RIO5 series remote modules; this speed is not available at the RIO5 series remote modules.

Selecting the speed at the CNC.

At the CNC, the transmission speed is selected by means of the machine parameters (parameter CANOPENFREQ).

Speed selection at the operator panels.

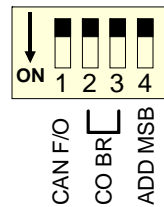

The speed is selected with switches ·2· and ·3· (CO BR).

In order for any change of speed to be assumed, the corresponding module must be reset; however, we recommend to change the speed while the modules and the CNC are off.



Speed selection at RIO5 remote modules.

SPEED



The speed is selected with the ·SPEED· switches.

In order for any change of speed to be assumed, the corresponding module must be reset; however, we recommend to change the speed while the modules and the CNC are off.



The communication at 250 kHz is not available at the RIO5 series remote modules.



FAGOR AUTOMATION

CNC 8070

(REF: 1709)

Speed selection at RIOR remote modules.

The speed is selected with switches ·2· and ·3· (CO BR).

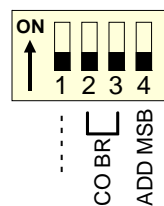

DS ·2·	DS ·3·	Speed	Length of the CAN bus.
on	on	1000 kHz	Up to 20 meters.
off	on	800 kHz	From 20 to 40 meters.
on	off	500 kHz	From 40 to 100 meters.
off	off	250 kHz	From 100 to 500 meters.

In order for any change of speed to be assumed, the corresponding module must be reset; however, we recommend to change the speed while the modules and the CNC are off.

Speed selection at RIOW remote modules.

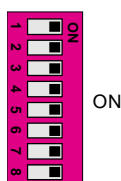

The dipswitch may be used to select the address of the node and the transmission speed.

To select the speed of the node, the module must be in configuration mode (all the dipswitches in the ·off· position). After turning the module on in configuration mode, the top 4 LED's of the module blink indicating the speed selected at the module. The STOP LED corresponds to dipswitch ·1·, the RUN to dipswitch ·2·, the TX to dipswitch ·3· and the RX to dipswitch ·4·. The first time the module is configured, the TX LED blinks indicating that no valid speed has been selected.



If when turning the module on, all the dipswitches are not in the ·off· position, the position of the dipswitches will be the new address (node number) of the group.

The first 4 dipswitches are used to select the speed; the rest must be in the ·off· position. To select the speed, put the corresponding dipswitches in the ·on· position.

Dipswitch ·1·	Dipswitch ·2·	Dipswitch ·3·	Dipswitch ·4·	Speed
Off	Off	Off	Off	1000 kHz
ON	Off	Off	Off	800 kHz
Off	ON	Off	Off	500 kHz
ON	ON	Off	Off	250 kHz

To save the selected speed, put dipswitch ·8· in the ·on· position. After saving the configuration, the corresponding LED's turn on to indicate the module speed. For 1 MHz, all four LED's turn on.

Once the speed has been selected, turn the module off by removing power and set dip-switch ·8· in the ·off· position. Bear in mind that the next time the module is turned on, the position of the dipswitches will indicate the address (node number) of the group.

12.4 Selecting the speed for the CANfagor bus.

When using the CANfagor protocol, the transmission speed at the bus is defined at the CNC (parameter CANLENGTH). The transmission speed depends on the total length of the cable. Use the following approximate values. Assigning other values may cause communication errors due to signal distortion.

Length (m)	Speed (KHz)	Length (m)	Speed (KHz)
20	1000	90	533
30	888	100	500
40	800	110	480
50	727	120	430
60	666	130	400
70	615	> 130	250
80	571		

12.

BUS CAN (CANFAGOR/CANOPEN PROTOCOLS).

13 SERCOS-II BUS.

The Sercos interface is a communications standard especially designed for the machine-tool industry offering a simple interface between the CNC and the drives. All the data and commands are transmitted in digital format through fiber optic lines that make up a ring (the Sercos ring) that connects all the elements of the bus (CNC and drives) to each other. Using the Sercos interface considerably minimizes the necessary hardware, makes cabling simpler and grants greater reliability to the system making it immune to electrical interference (noise).

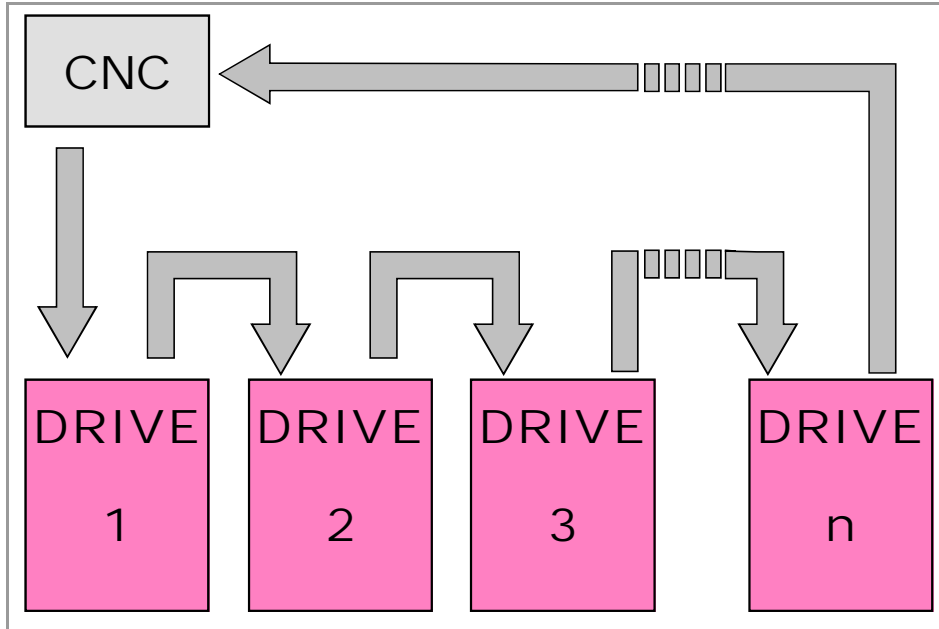

13.

SERCOS-II BUS.

Sercos cable characteristics.

Fagor Automation supplies the fiber optic cables needed for Sercos communication. There are several types of cable depending on their length and their dynamic and static installation characteristics.

- Fiber optic cable with polymer core (SFO, SFO-FLEX) for up to 40 meters. If the fiber optic cable is going to withstand dynamic conditions (moving), always use the SFO-FLEX cable. If the fiber optic cable is going to withstand static conditions (not moving), always use the SFO cable.
- Fiber optic cable with glass core (SFO-V-FLEX) for over 40 meters.

Mechanical cable characteristics.

SFO cable.	
Flexibility.	Normal. Minimum bending radius of 30 mm. Only to be used in static systems (not moving).
Cover.	PUR. Polyurethane resistant to chemicals used in machines.
Temperature.	Working: -20 °C / 80 °C (-4 °F / 176 °F). Storage: -35 °C / 85 °C (-31 °F / 158 °F).
SFO-FLEX cable.	
Flexibility.	High. Minimum bending radius, static = 50 mm and dynamic = 70 mm. Special cable to be used in cable chains.
Cover.	PUR. Polyurethane resistant to chemicals used in machines.
Temperature.	Working: -20 °C / 70 °C (-4 °F / 158 °F). Storage: -40 °C / 80 °C (-40 °F / 176 °F).

FAGOR 

FAGOR AUTOMATION

CNC 8070

(REF: 1709)

SFO-V-FLEX cable.	
Flexibility.	Minimum bending radius, static = 45 mm and dynamic = 60 mm.
Cover.	PUR. Polyurethane resistant to chemicals used in machines.
Temperature.	Working: -40 °C / 80 °C (-40 °F / 176 °F). Storage: -40 °C / 80 °C (-40 °F / 176 °F).

13.

SERCOS-II BUS.

Cable handling.

The cable provided by Fagor has its pins protected with a hood. Before connecting the cable, remove the protecting hood.

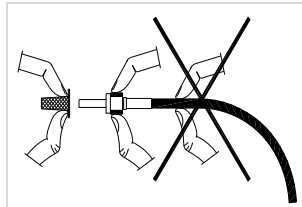

Both for removing the pins protecting hood for the pins and for plugging and unplugging the cable, hold the cable by its pin, never pull at the cable while holding it by its plastic part because it could make it useless.

13.1 Module identification and connection

Module identification.

The drives are identified with the 16-bit rotary switch "Address" (also called "Node_Select"). This switch selects the address (node) occupied by each of the elements integrated into the Sercos connection. The CNC do not has the switch; it is pre-configured to always occupy position -0- at the bus.

The CNC must always occupy position 0 and the drives will occupy consecutive positions starting with 1. In order for any change at the "Address" switch to be assumed, the corresponding drive must be reset and the CNC powered off and back on.

Whether the drive identified with number 1 (for example) corresponds to the X axis, to the Y axis or to another one is irrelevant. However, it is a good idea, for clarity sake, that the machine axes X, Y, Z, U, V, W, A, B and C be assigned consecutive numbers in that order.



Then set certain CNC machine parameters to configure the connection.

Module interconnection.

The Sercos connection is carried out in a ring using fiber optic cable by joining an OUT terminal with an IN terminal. The drawing shows the Sercos connection of the CNC with Fagor spindle drives and the X, Y axes.

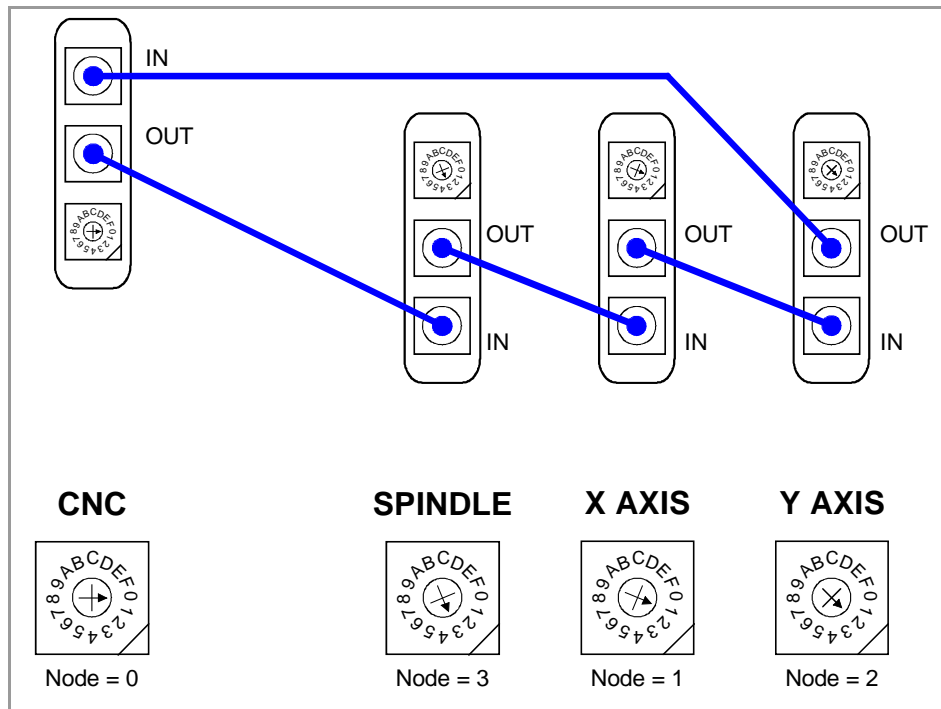

13.2 Data exchange via Sercos.

The data exchange between the CNC and the drives takes place in each position loop. The more data is exchanged, the more overloaded the Sercos transmission will be. These registers should be limited leaving only the ones absolutely necessary after the setup.

There is data that must necessarily be transmitted in every position loop (velocity commands, feedback, etc.) and other data that may be transmitted in several loops (monitoring, etc.). Since the CNC must know the priority of those transmissions, there must be two separate transmission channels.

Cyclic channel (fast).

The data is transmitted in every position loop. It contains velocity commands, feedback, etc. Each variable that is read or written at the drive is included in this data pack. In order not to overload the interface, you must limit the number of drive variables involved to the minimum necessary.

Indicate the type of data to be transmitted. The data to be sent to the drives must be placed in certain particular registers of the PLC and the data to be read from the drives is received in other registers of the PLC.

Service channel (slow).

The data is transmitted in several position loops. It contains monitoring data, etc.

This channel can only be accessed through high-level blocks in the part-program or from the PLC channel.

13.

SERCOS-II BUS.



FAGOR AUTOMATION

CNC 8070

(REF: 1709)

14 MECHATROLINK BUS.

The Mechatrolink bus may be used to communicate with servos (axis and spindle) and inverters (spindle) in Mlink-I (17 bytes) mode and Mlink-II (17 or 32 bytes) mode. With this type of bus, up to 14 slaves may be connected in Mlink-I mode and 30 slaves in Mlink-II mode (a repeater must be used to connect more than 16 slaves).

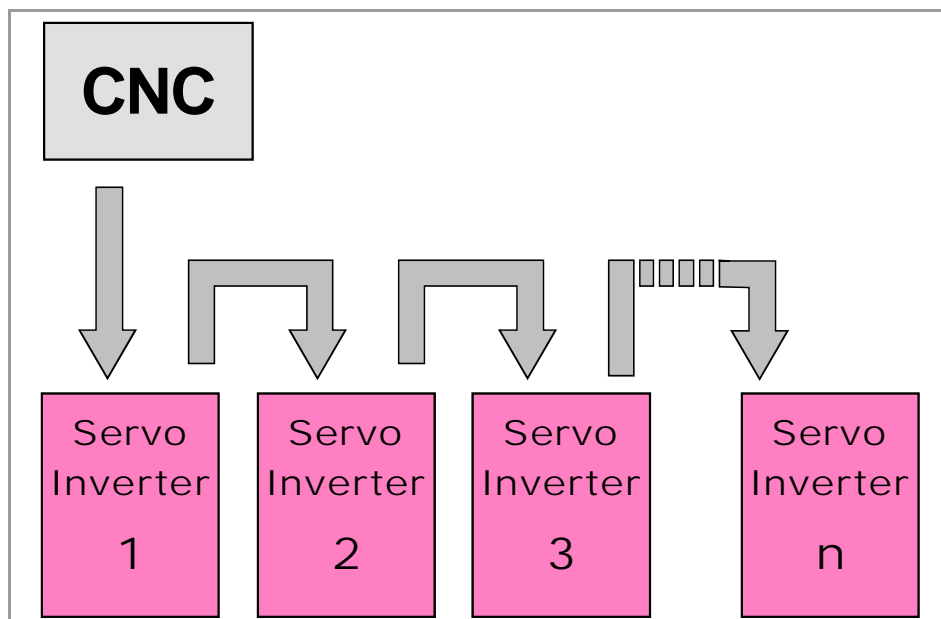

Mechatrolink cable characteristics.

Use a specific Mechatrolink cable. The maximum length of the cable is 50 m (164 ft). The minimum length of the cable between elements is 0.3m (1 ft) in Mlink-I mode and 0.5 m (1.7 ft) in Mlink-II mode.

Item.	Description.
Type.	Shielded. Twisted pair.
Impedance.	130 Ω.

Twisted-pair shielded cable should be used to minimize interference between cables, thus preventing poor communication in long lengths.

Identification of the first and last elements of the bus. Line terminating resistor.

In the bus, it is necessary to use a line terminating resistor to identify which are the elements that occupy the ends of the bus; i.e. the first and last physical element in the connection. For the central unit, the terminating resistor is factory installed because the CNC is always at one end of the bus.

14.

MECHATROLINK BUS.



FAGOR AUTOMATION

CNC 8070

(REF: 1709)

15 INSTALLING AND CONFIGURING A THIN CLIENT (EPATEC MODEL).

The Thin Client is recommended for configurations where the VGA cable cannot be used to connect the central unit with a second monitor (e.g. the passive screen LCD-15SVGA) due to too much distance. The central unit and the Thin Client will communicate via Ethernet (local network or point to point) and the Thin Client will be in charge of sending the VGA signal to the passive screen. Both monitors show the same video signal. A mouse connected to the Thin Client may also be used with to interact with the CNC.

The central unit and the Thin Client communicate through a remote desktop software, in this case VNC, where the CNC is the server and the Think Client is the client.

The passive screen permits having a second work station consisting of the screen itself and an operator panel OP-PANEL-H/E. Connect the operator panel to the CAN bus of the system and the softkeys of the screen to the operator panel.



The softkeys of the passive screen will only operative if they are connected to the horizontal or vertical keyboard.

Point-to-point connection.

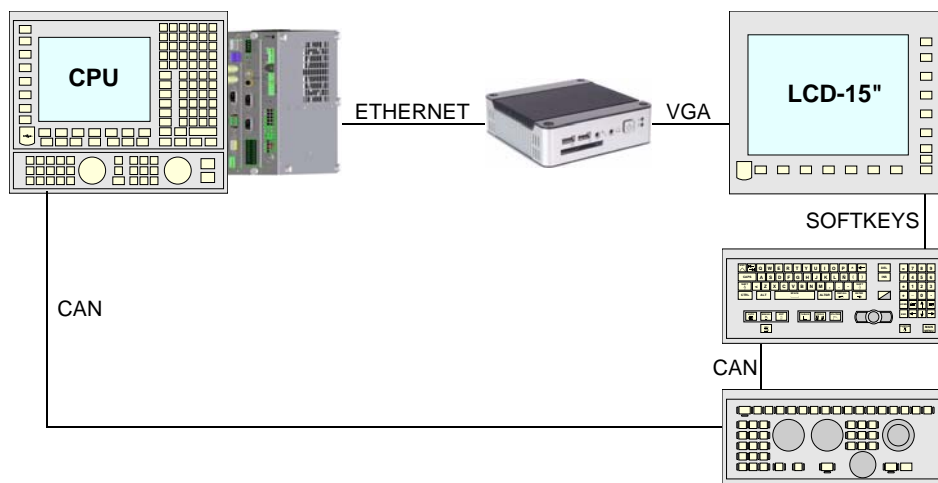

Connection within a local network (LAN).

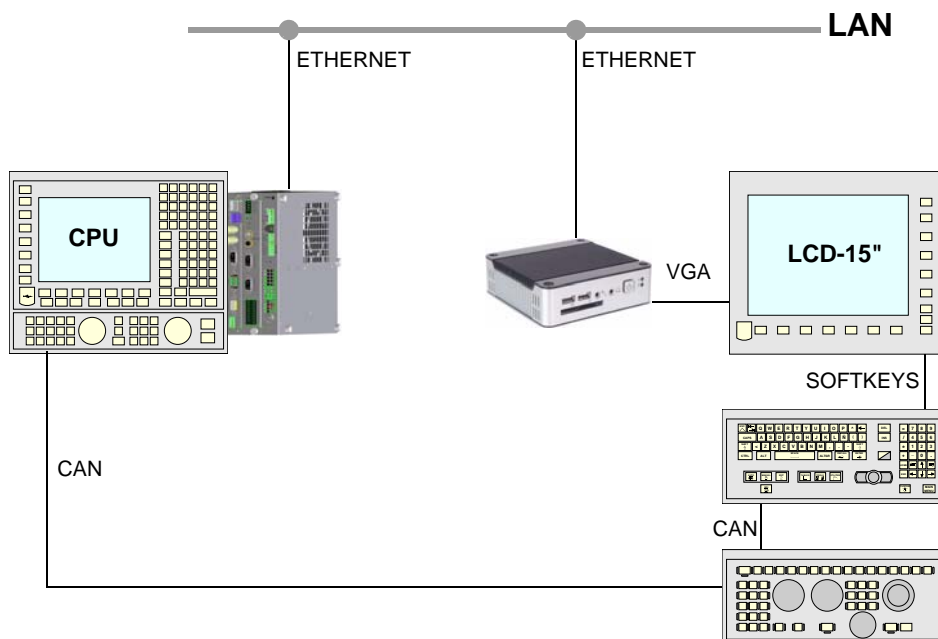

15.

INSTALLING AND CONFIGURING A THIN CLIENT (EPATEC MODEL).



FAGOR AUTOMATION

CNC 8070

(REF: 1709)

Cable characteristics.

A cross cable must be used when connecting the Thin Client directly to the CNC (point-to-point connection). A standard 10BASE-T shielded cable must be used when connecting the Thin Client to a switch or within a local network. In either case, use a specific Ethernet cable.

Ethernet cable.	
Type.	Twisted pair. Shielded.
Impedance.	Cat.5 (100Ω - 120Ω) or greater.
Maximum length.	100 meters (328 ft).

In order to ensure proper performance, the connection cable must be inserted all the way into the connectors so they're latched. This ensures that the cable is properly latched and does not come off due to vibration.

15.

INSTALLING AND CONFIGURING A THIN CLIENT (EPATEC MODEL).



FAGOR AUTOMATION

CNC 8070

(REF: 1709)

15.1 Install and configure the communication software at the CNC.

The central unit and the Thin Client communicate through a third-party remote desktop software, in this case VNC. To install the VNC software, the CNC must be set in administrator mode. Refer to the installation manual for further detail.



The access to the administrator mode is enabled with the validation code ("Open system" software option). If you don't have this software option, (i.e. you have a "closed system") you will not be able to access the administrator mode and, therefore, you will not be able to install third-party software. If the CNC is not in administrator mode, the changes made to protected folders or files will be operative until the unit is turned off and back on, the CNC will then restore the initial configuration. The changes made to unprotected areas of the disk will remain.

15.

During installation, follow the instructions appearing on the screen and, if necessary, select the following options.

- 1 Install only the "VNC Server" component.

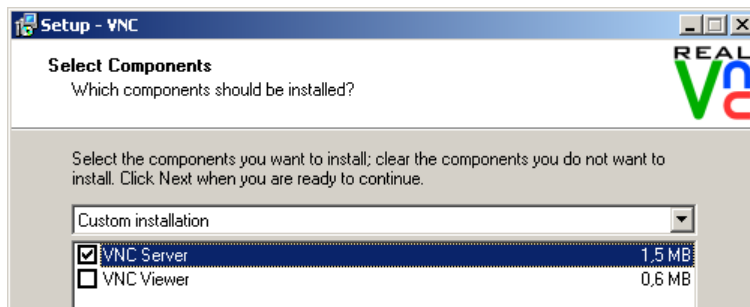

- 2 Select the following configuration options. With this configuration, start the CNC up, the VNC will remain waiting and its icon will appear in the notification area of the task bar (next to the clock).

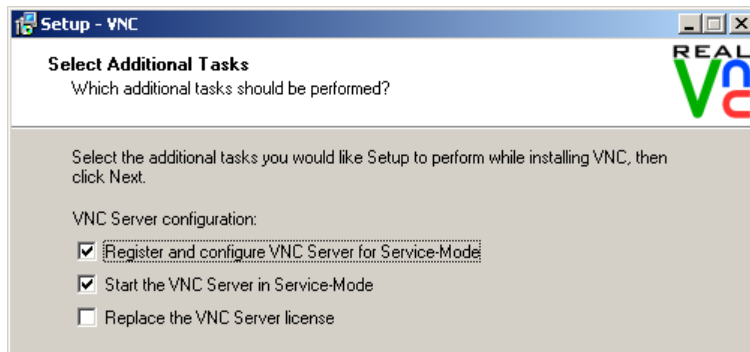

- 3 When installation is done, the program shows the following option tabs.

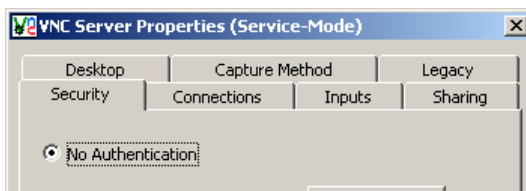

- on the "Security" tab, select "No Authentication".

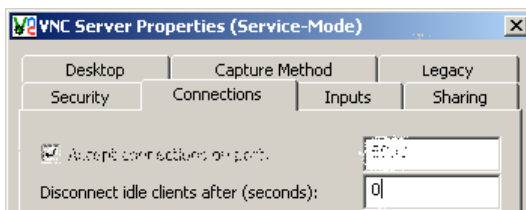

- On the "Connections" tab, select "Disconnect idle clients after (seconds)" with 0 seconds.

INSTALLING AND CONFIGURING A THIN CLIENT (EPATEC MODEL).



FAGOR AUTOMATION

CNC 8070

(REF: 1709)

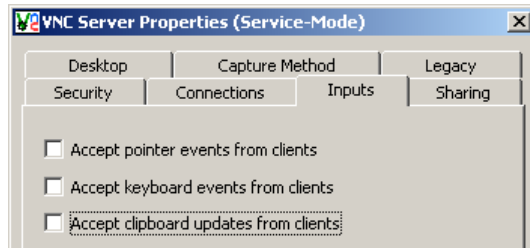

- On the "Inputs" tab, de-select the options "Accept keyboard events from clients" and "Accept clipboard updates from clients".
- The option "Accept pointer events from clients" is only taken into account when a mouse is connected to the Thin Client. When selecting this option, the Thin Client sends mouse events to the CNC.

15.**INSTALLING AND CONFIGURING A THIN CLIENT (EPATEC MODEL).**

15.2 Configuring the Thin Client.

15.2.1 Configure the network protocol (for network or point-to-point connection).



The software of the Thin Client has its own manual that is available on the manufacturer's website. In case of doubt, refer to the manufacturer's documentation.

The first time the Thin Client is turned on, a setup assistant comes up (language, IP address, etc.). When necessary, in the option "Do you want this terminal to be managed by a Scout NG manager?", select "No".

When the Thin Client startup is done, it shows several tabs that may also be used to configure the Thin Client. On the "Setup > Network" tab, select the "Manually" option and set the IP address (e.g. 10.0.0.102) and the network mask (e.g. 255.255.0.0). The network mask must be the same at the Thin Client and at the CNC.

The screenshot shows the 'eLux NG' configuration window with the 'Setup' tab selected. Under the 'Network' sub-tab, the 'Manually' radio button is selected. The 'IP address' field is set to '10.0.0.102' and the 'Subnet' field is set to '255.255.0.0'. Other fields include 'Hostname' (eLux), 'Domain', and 'DNS'. There are 'Add' and 'Delete' buttons for both the IP address and DNS fields. At the bottom, there are 'Apply' and 'Reset' buttons.

15.

INSTALLING AND CONFIGURING A THIN CLIENT (EPATEC MODEL).

15.2.2 Configure the communication between the CNC and the Thin Client.

The Thin Client comes with a VNC client software. To configure the VNC start command, select the tab Configuration > New > Local and define the following data.

Name	VNC (or the desired name)
Application	Custom
Parameter	vncviewer10.0.7.250:0 -fullscreen (IP address of the CNC)
Start automatically	Select this option with a value of 5 s (illustrative value).
Application restart	Select this option so the Thin Client tries to re-establish communication without having to restart the system in case of communication loss for some time (because the Ethernet cable has been disconnected, for example).

15.

INSTALLING AND CONFIGURING A THIN CLIENT (EPATEC MODEL).



The purpose of the "Start automatically" parameter is to start the VNC client of the Thin Client after the VNC of the CNC has been started up. The value of this parameter depends largely on how both devices, central unit and Thin Client, start up. If both elements start up at the same time or the Thin Client starts before the VNC server is available at the CNC, the VNC customer of the Thin Client cannot be connected and it will issue a connection error or data reading error. In this case, the time set for parameter "Start automatically" will have to be increased.

If the startup of the Thin Client depends on the CNC being started up first (e.g. condition the startup of the Thin Client to a PLC output), this "Start automatically" parameter could be set to 0 (zero).

Together with the command, it launches the IP address to which the Thin Client is connected. The address may be changed from Configuration > Edit > Local, in the Parameter window.



FAGOR AUTOMATION

CNC 8070

(REF: 1709)

15.2.3 Configuring the startup of the Thin Client.

The BIOS must be modified in order for the Thin Client to start up automatically when powered on, without having to press the ON button. Having the Thin Client OFF, connect the external keyboard and, while starting up, press the [DEL] key to access the BIOS. The right side of the BIOS shows a menu with the instructions to browse through the BIOS.



The BIOS is an essential part in the operation of the Thin Client. Do not change any other parameter of the BIOS. The wrong manipulation of the BIOS parameters may render it useless.

- Once in the BIOS, select "Advanced > APM configuration" and access the options menu.

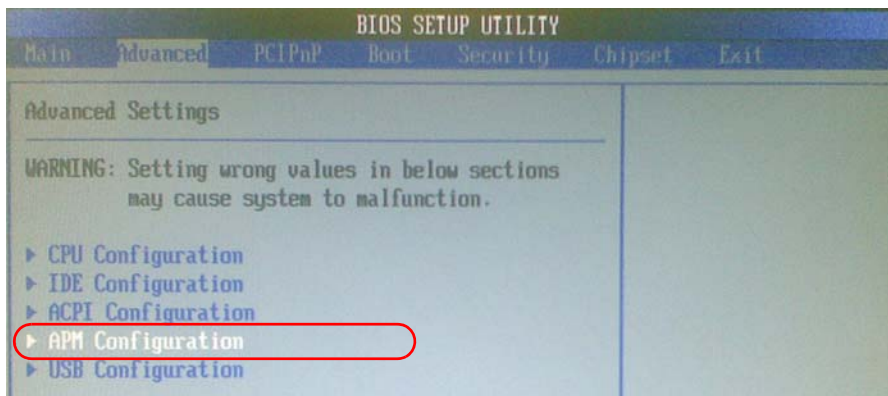

- Inside the menu "APM configuration", set the "Restore on AC/Power Loss" to [Power On].

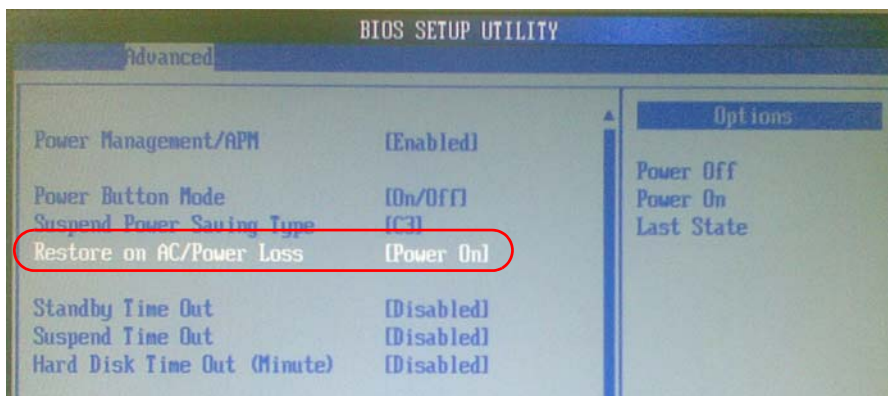

- Get out of the BIOS saving the changes.

15.2.4 Disable the mouse at the Thin Client.

Once the setup of the Thin Client is done, the mouse must be disabled so the screen does not show the cursor.

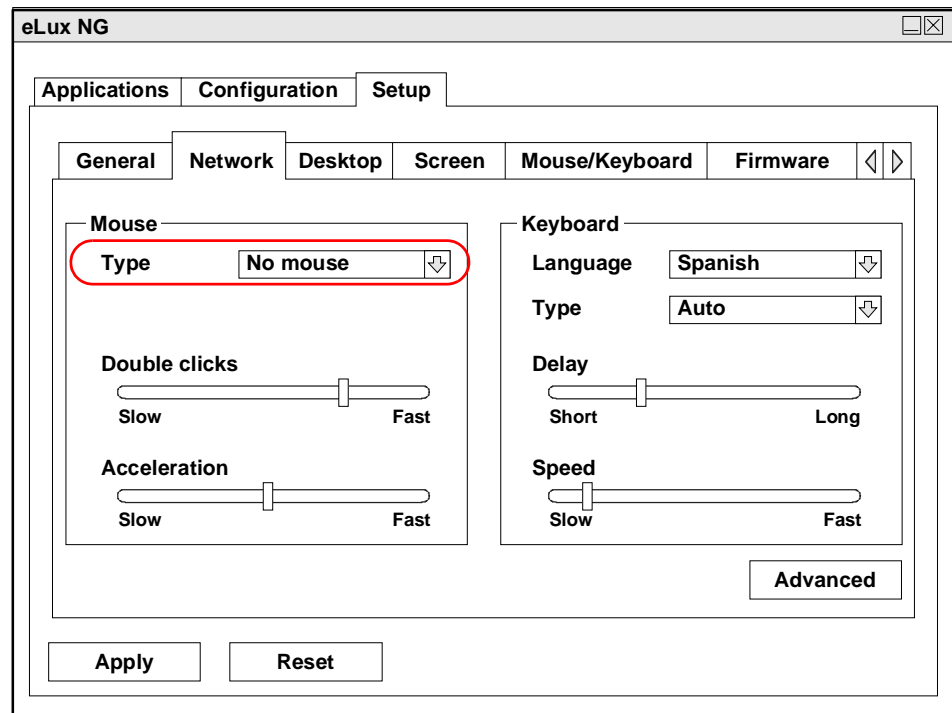
**15.**

INSTALLING AND CONFIGURING A THIN CLIENT (EPATEC MODEL).

16 INSTALLING A SENSOR FOR GAP CONTROL (LASER MODEL).

The analog input for the sensor can be installed in remote CAN modules or on the Sercos drive of any axis. Fagor Automation recommends using a drive input. Use the machine parameters GAPANAINTYPE and GAPANAINID to define the CNC where the sensor input is located.

Electrical diagram.

Connecting the sensor to an analog input of the Sercos drive.

The example uses the first analog input of the drive (pins ·4· and ·5·); to use the second input, use pins ·2· and ·3·.

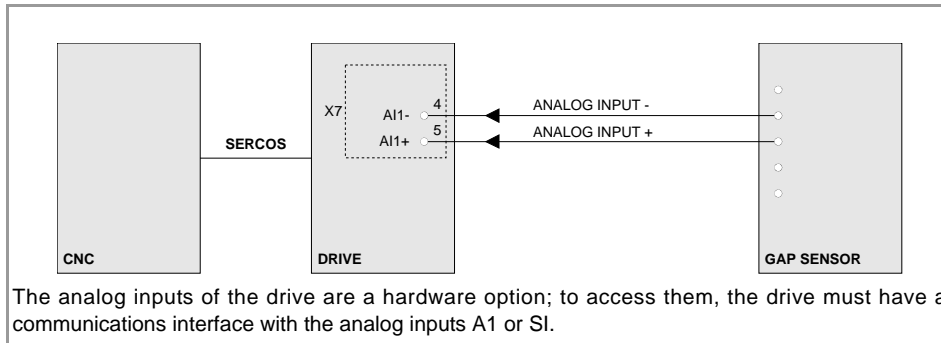

The analog inputs of the drive are a hardware option; to access them, the drive must have a communications interface with the analog inputs A1 or SI.

Connecting a sensor to an analog input on remote modules.

The analog inputs are available on modules RIO5 and RIOR.

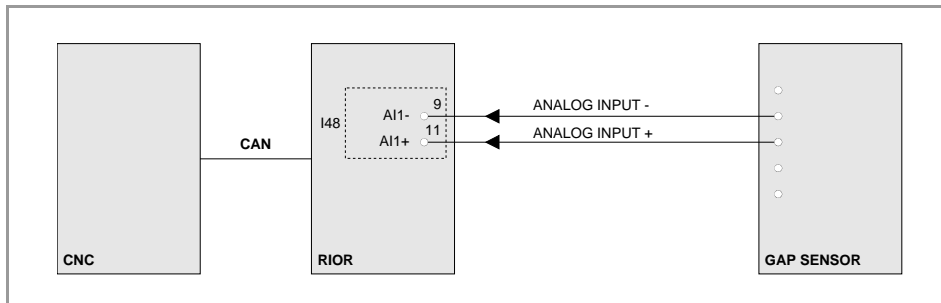

16.

INSTALLING A SENSOR FOR GAP CONTROL (LASER MODEL).



FAGOR AUTOMATION

Fagor Automation S. Coop.

Bº San Andrés, 19 - Apdo. 144
E-20500 Arrasate-Mondragón, Spain

Tel: +34 943 719 200

+34 943 039 800

Fax: +34 943 791 712

E-mail: info@fagorautomation.es

www.fagorautomation.com